

ARCHITECTURAL SIGNAGE



COSIGN

MODULAR SIGN SYSTEMS & WAY FINDING SOLUTIONS

INTERIOR / INTERIÖRT

FLEXIBLE

I-SIGN FLEX	06
I-SIGN FIX	08
FLAG	10
I-SIGN DISPLAY / DISPLAY SLIM	12
STRATO	16
CURVO PLUS	20

MODULAR

MODULE PLUS INDOOR	24
--------------------	----

LED SIGNS

LIGHTBOX	32
HIGHLIGHT	34
SOLED	36
LED LIGHT SHEETS	38

TEXTILE FRAMES

SINGLE & DOUBLE SIDED	40
-----------------------	----

TENSION

TENSION PROFILES	46
------------------	----

FIXINGS & SUSPENSION

INOX & ALUMINIUM FIXINGS	48
SUSPENSION KITS	52

EXTERIOR / EXTERIÖRT

MODULAR

MODULE PLUS OUTDOOR	56
---------------------	----

TOTEMS

TOTEM PYLONS	60
--------------	----

HIGH QUALITY

CUSTOMISATION

INNOVATION

LARGE STOCK

EXPERIENCE

FLEXIBLE

SERVICE

ALLTID HÖG KVALITET

ANPASSNINGSBART

INNOVATIVT

**GENOMTÄNKT
LAGERHÅLLNING**

ERFARENHET

FLEXIBELT

SERVICE

COSIGN

MODULAR SIGN SYSTEMS



YOUR GLOBAL PARTNER IN SIGN

Cosign was established in 1993. Over the last 25 years it has become the unsurpassed reference with regard to architectural signage.

No matter what type of signs you need, for indoor or outdoor use, flexible or modular, with or without LED technology, if desired with fabric, advertising pillars or spacers, Cosign is the right address.

Cosign is a global player with production facilities and distribution centres in Belgium (headquarters), India, Mexico, Brazil and Hong Kong.

Our extensive range of products is unique. We are able to deliver quickly due to our large supply of stock. Twenty years of experience, well-organised logistical transactions and perfect service make Cosign a reliable partner that you can trust.

Cosign constantly works on innovative solutions for the sign industry together with top designers like Stefan Schöning, Bart Bauwens (IDnA) and Fabrique.

DIN GLOBALA SKYLTPARTNER

Cosign etablerades redan 1993. Över de senaste 25 åren har Cosign blivit synonymt med arkitektonisk skyltning.

Det spelar ingen roll vilken typ av skyltar du behöver, skyltar för inomhusbruk eller utomhusbruk, flexibla eller modulära skyltar, skyltar med integrerad LED-teknik, annonspelarliknande skyltar, eller om så önskas skyltar med textilväv, Cosign är företaget du ska vända dig till.

Cosign är en global aktör med produktionsfaciliteter och distributionshubbar i Belgien (huvudkontor), Indien, Mexico, Brasilien och Hong Kong.

Vårt stora utbud av produkter är unikt. Tack vare vårt stora lager, kan vi styra upp snabba leveranser. Tjugo år av erfarenhet, välorganiserad logistik kring transporter, tillsammans med utmärkt service gör Cosign till en skyltleverantör och partner du kan lita på.

Cosign arbetar konstant med att utveckla innovativa lösningar till skyltindustrin tillsammans med toppdesigners som Stefan Schöning, Bart Bauwens (IDnA) och Fabrique.

DOOR SIGNS
INFORMATION SIGNS
GENERAL SIGNS
ORIENTATION SIGNS
EVACUATION PLANS
NAMEPLATES

DÖRRSKYLTA
INFORMATIONSSKYLTA
ALLMÄN SKYLTING
HÄNVISNINGSSKYLTA
UTRYMNINGSSPLANER
NAMNSKYLTA



I-SIGN

STRATO

FLEXIBLE AND MULTIFUNCTIONAL

Our flexible sign systems offer the perfect solution for environments where signs and graphics have to be replaced frequently. You can create and update new signs in no time using your printer. You can use paper as well as other materials such as acrylic, metal and engraving plates, or PVC.

The flexible signs are deployed as a wall sign, suspended sign, table stand or as a flag mounted model.

Our flexible systems are not only available as a ready-made product in standard sizes (including the most frequently used DIN and sign sizes). They are also available as a profile system with accessories so the sign maker can put together his/her own signs. You can also request a custom-made product if you order larger quantities.

FLEXIBLE



CURVO PLUS

I-FLAG

FLEXIBLA OCH MULTIFUNKTIONELLA

Våra flexibla skyltsystem erbjuder den perfekta lösningen i situationer där skyltbudskapet, eller i vissa fall hela skylten, måste kunna bytas ut på ett enkelt och smidigt sätt. Du skapar själv skyltbudskapet med dator och vanlig kontorsskrivare. Du kan alltså använda vanligt papper, men givetvis går det även bra med material som akryl, metall och PVC om du vill skapa något mer avancerat, som t.ex. en graverad eller taktil skylt.

De flexibla skyltarna finns i flera olika utföranden; väggmonterade skyltar, hängande skyltar, utstickande flaggskyltar och även bordsstående skyltar.

Skyltsystemen finns tillgängliga i standardformat hämtade från A-serien (t.ex A5, A4, A3 osv). Utöver standardformaten finns även aluminiumprofilerna och alla tillbehör, så som sidstycken och fästen, tillgängliga så att det går att kapa till och bygga en skylt efter egna mått. Dessutom, vid order av en större kvantitet, finns möjligheten att beställa specialtillverkade produkter.

I-SIGN FLEX



www.cosign.nu

I-Sign Flex is an intelligent, modern sign system with a few unique characteristics:

1. The top of the acrylic cover plate is at the same level as the top of the aluminium frame with a visible rim of only 2.5 mm.
2. The I-Sign Flex comes with a spring system; this makes it very easy to remove the acrylic plate and replace the insert.
3. When mounting on a wall you can use double-sided tape or adjustable mount buttons.
4. The I-Sign Flex has a lock function to prevent vandalism.

I-SIGN Flex är en intelligent, modernt skyltsystem med flera karakteristiska drag:

1. Slimmad design. När skylten är ihopmonterad så ligger skyddsplasten i akryl på samma nivå som själva skylttramen i aluminium.
2. I-Sign Flex ramarna har en fjädrande konstruktion; Detta gör det extremt lätt att öppna och byta ut skyltbudskapet.
3. Flera alternativ vid väggmontering. Det går att använda dubbelhäftande tejp eller om man vill skruva upp skyltarna finns det "monteringsknappar" som är justerbara.
4. I-Sign Flex har en låsfunktion för att förebygga vandalism.
5. I-Sign skylttramen finns i både aluminium och ABS-plast.

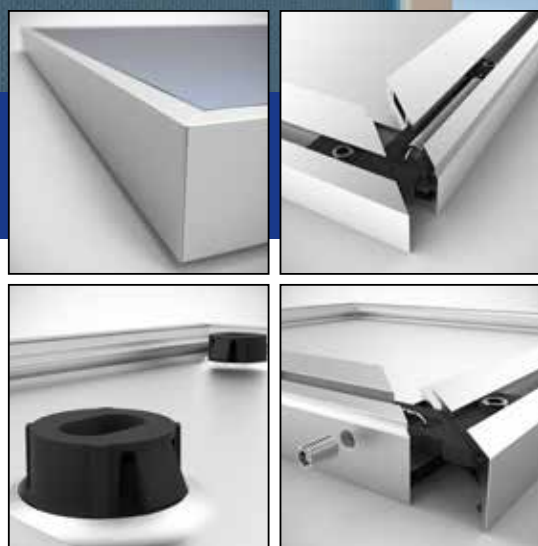

För information på svenska, besök www.cosign.nu/h/category.html/i-sign



STANDARD SIZES

STANDARDSTORLEKAR

WALL MOUNTED VÄGGMONTERAD



product code	insert (hwxw) in mm / instick (hxl) i mm
I-052148-W	52 x 148,5
I-060210-W	60 x 210
I-105107-W	105 x 107
I-105148-W	105 x 148,5 (DIN A6)
I-105148-WS	105 x 148,5 (DIN A6 slider)
I-148150-W	148,5 x 150,5
I-210148-W	210 x 148,5 (DIN A5)
I-210212-W	210 x 212
I-210297-W	210 x 297 (DIN A4 landscape)
I-297210-W	297 x 210 (DIN A4 portrait)
I-297299-W	297 x 299
I-420297-W	420 x 297 (DIN A3 portrait)
I-594420-W	594 x 420 (DIN A2)
I-841594-W	841 x 594 (DIN A1)

SUSPENDED HÄNGANDE/NEDPENDLAD



product code	insert (hwxw) in mm / instick (hxl) i mm
I-148297-S	148,5 x 297
I-148420-S	148,5 x 420
I-148600-S	148,5 x 600
I-148840-S	148,5 x 840
I-210297-S	210 x 297
I-210420-S	210 x 420
I-210600-S	210 x 600
I-210840-S	210 x 840

PROJECTED UTSTICKANDE (FLAGGSKYLTT)



product code	insert (hwxw) in mm / instick (hxl) i mm
I-150148-P	150,5 x 148,5
I-212210-P	212 x 210
I-210297-P	210 x 297
I-297210-P	297 x 210

TABLE STAND BORDSSTÄENDE



product code	insert (hwxw) in mm / instick (hxl) i mm
I-052148-T	52 x 148,5

PROFILES & ACCESSORIES

PROFILER & TILLBEHÖR

PROJECTING PROFILE UTSTICKANDE PROFIL (PROFIL TILL FLAGGSKYLTT)

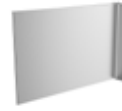

product code	description	
FLAG2000	anodised / anodiserad	5m/l

PROJECTING BRACKET FÄSTE TILL UTSTICKANDE FLAGGPROFIL



product code
I-BRACKET

SUCTION CUP VAKUUM SUGPROPP



product code
VACUUMC2

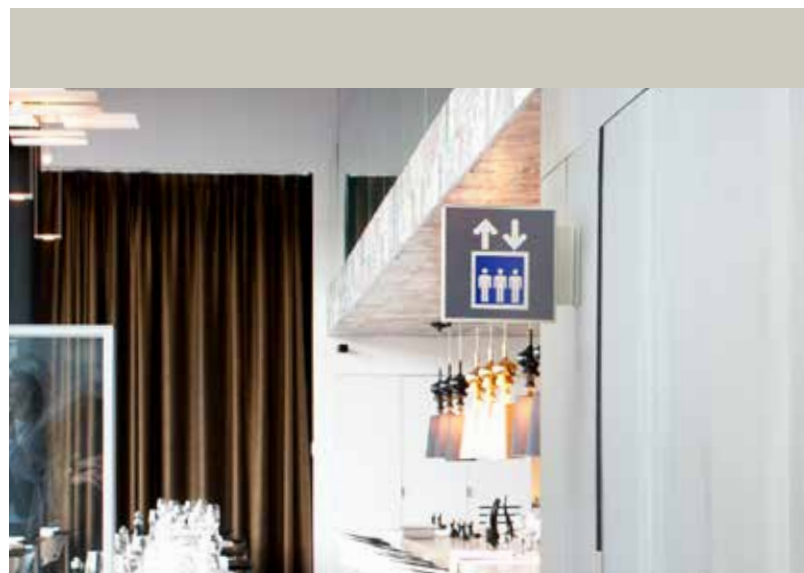

I-SIGN FIX



www.cosign.be/isignfix

The sleek design of the I-Sign range is extended to the I-Sign Fix; observe the elegant frame with invisible fixings.

Sheets of only 2 or 3 mm thick are mounted in the frame with a small, innovative clip. The sheets can be made from various materials: PVC, ACM, acrylic, aluminium, engraving materials, etc. This results in a high degree of personalisation.

Precis som de andra skyltarna i I-Sign serien har I-Sign Fix samma slimmade designen. Notera hur den enkla, men samtidigt eleganta skylt ramen har dolt infästning för skyltbudskap.

Skivmaterial med tjocklek 2-3mm kan monteras i ramen med små, innovativa clips (antingen med häftämne eller magnet). I-Sign Fix funkar alltså utmärkt till t.ex. taktila skyltar och skivmaterial i t.ex. PVC, ACM, akryl, aluminium och andra gravyrmaterial. Tack vare denna smarta lösning kan skylt ramen fungera till många olika typer av skyltar.

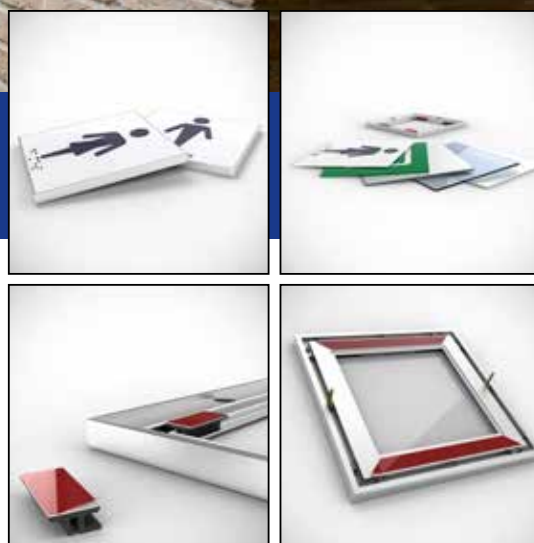

För information på svenska, besök www.cosign.nu/h/category.html/i-sign



STANDARD SIZES

STANDARDSTORLEKAR

WALL MOUNTED VÄGGMONTERAD



product code	insert (hwxw) in mm / instick (hxl) i mm
IF-150150-W	150 x 150
IF-150300-W	150 x 300
IF-150600-W	150 x 600
IF-297210-W	297 x 210 (DIN A4)
IF-297420-W	297 x 420 (DIN A3)

SUSPENDED HÄNGANDE/NEDPENDLAD



product code	insert (hwxw) in mm / instick (hxl) i mm
IF-150150-S	150 x 150
IF-150300-S	150 x 300
IF-150600-S	150 x 600

PROJECTED UTSTICKANDE (FLAGGSKYLTT)



product code	insert (hwxw) in mm / instick (hxl) i mm
IF-150150-P	150 x 150
IF-150300-P	150 x 300
I-FLAG	150 x 161

SUCTION CUP / VAKUUM SUGPROPP



product code
VACUUMC2

PROFILES & ACCESSORIES

PROFILER & TILLBEHÖR

ALUMINIUM PROFILES ALUMINIUMPROFILER



product code	description
IF-WM1000	wall mounted / väggmonterad mill finish / mill 5m/l
IF-WM2000	anodised / anodiserad 5m/l
IF-WM5000	black anodised / anod. svart 5m/l



product code	description
IF-SP1000	suspended / hängande mill finish / mill 5m/l
IF-SP2000	anodised / anodiserad 5m/l



product code	description
FLAG2000	projected / utstickande anodised / anodiserad 5m/l

PROJECTING BRACKET FÄSTE TILL UTSTICKANDE FLAGGPROFIL



product code
I-BRACKET

CORNER SECTION / HÖRNBIT



product code
IF-CORNER

MOUNTING CLIP / MONTERINGSKLIPPS



product code
I-CLIP

CONNECTOR / CONNECTOR



product code
I-CONNECTOR

HANGING CLIP / KLIPPS FÖR HÄNGANDE SKYLTT



product code
APC-3000S

HANGING KIT / VAJERKIT



product code	description
APC4101	2x conical clip + 1,5m wire 2x klipps + 1,5m vajer



I-FLAG



www.cosign.nu

Cosign developed a universal FLAG profile which can be used as a stand-alone product - to be mounted directly to the wall or ceiling - or in combination with other Cosign products like the I-Sign Eco, I-Sign Flex or I-Sign Fix frames.

First an aluminium mounting profile is fixed to the wall or ceiling, then the flag profile - with or without frames mounted on it - is slid over this mounting profile and fixed with a set screw.

Cosign har utvecklat en universal flaggprofil som kan monteras på vägg eller i tak. Denna produkt kan användas både som den är, "stand-alone", så att säga, eller så kan man kombinera flaggprofilen med andra Cosign produkter, så som I-Sign Eco, I-Sign Flex eller I-Sign Fix.

Först monterar man ett aluminiumfäste i tak eller på vägg. Sedan trär man på själva flaggprofilen på aluminiumfästet och fixerar med skruvar.

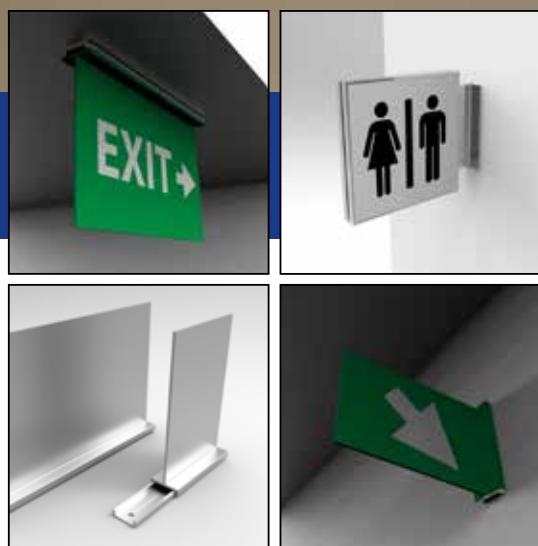

För information på svenska, besök www.cosign.nu/h/category.html/i-sign

STANDARD SIZES

STANDARDSTORLEKAR

I-FLAG 1

In combination with I-Sign Fix/Flex
I kombination med I-Sign Fix/Flex



product code

I-FLAG1

I-Flag 1 with mount 100mm
I-Flag 1 profil med höjd 100mm

I-FLAG 2



product code

I-FLAG2-150

I-Flag 2 with mount 150mm
I-Flag 2 profil med höjd 150mm

I-FLAG2-300

I-Flag 2 with mount 300mm
I-Flag 2profil med höjd 300mm

I-FLAG 3

In combination with I-Sign Eco
I kombination med I-Sign Eco



product code

I-FLAG3-100

I-Flag 3 with mount 100mm
I-Flag 3 profil med höjd 100mm

I-FLAG3-150

I-Flag 3 with mount 150mm
I-Flag 3 profil med höjd 150mm

PROFILES & ACCESSORIES

PROFILER & TILLEBHÖR

FLAG1-2000

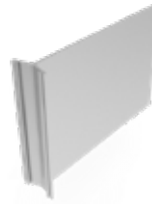

product code description

FLAG1-2000

anodised / anodiserad

5m/l

FLAG2-2000



product code description

FLAG2-2000

anodised / anodiserad

5m/l

MOUNT2-2000



MOUNT2-2000

anodised / anodiserad

5m/l

PROJECTING BRACKET FÄSTE TILL UTSTICKANDE FLAGGPROFIL



product code

I-BRACKET

Bracket for Flag1-2000
Fäste för Flag1-2000



I-SIGN DISPLAY



www.cosign.nu

The single-sided I-Sign Display profiles make it possible to frame large panels, digital prints and art virtually without an edge and without visible fixings. This makes them very suitable for use in museums, galleries and interior decoration.

The double-sided profile is extremely suitable for making thin light boxes and illuminated or non-illuminated indoor pillars.

Double-sided tape, magnetic tape or the 3M Dual Lock™ reclosable fastener can be used to affix the panels.

Den enkelsidiga I-Sign Displayprofilen gör det möjligt att rama in större skivor med t.ex. digital-printade motiv eller reproduktioner av konstverk, i princip helt utan synlig kant. Detta gör produkten ytterst lämplig för museum, gallerior och andra offentliga platser med behov av inredningsdekor eller konstnärliga utsmyckningar.

Den dubbelsidiga I-Sign Displayprofilen är lämplig till tunna ljuslådor och stora golvstående skyltar med eller utan inbyggd LED-belysning.

Det finns flera alternativ för hur man monterar skyltbudskapet I-Sign Display ramen, t.ex. dubbelsidig tejp, magnetisk tejp eller 3M's Dual Lock™ som är ett fästsystem för snabba upp- och nedmonteringar.

För information på svenska, besök www.cosign.nu/h/category.html/i-sign



CUSTOM
MADE

DESIGN

PROFILES &
ACCESSORIES

DESIGN

SINGLE-SIDED

ENKELSIDIG

ALUMINIUM PROFILE / ALUMINIUMPROFILER

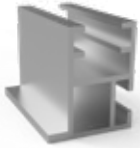

product code	description	
ID-SS1000	mill finish / mill	5m/l
ID-SS2000	anodised / anodiserad	5m/l
ID-SS5000	black anodised / anod. svart	5m/l

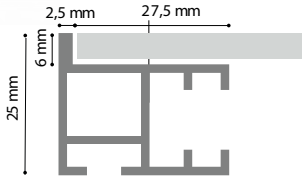

CORNER CONNECTOR / HÖRNFÄSTE



product code
ID-SS CORNER

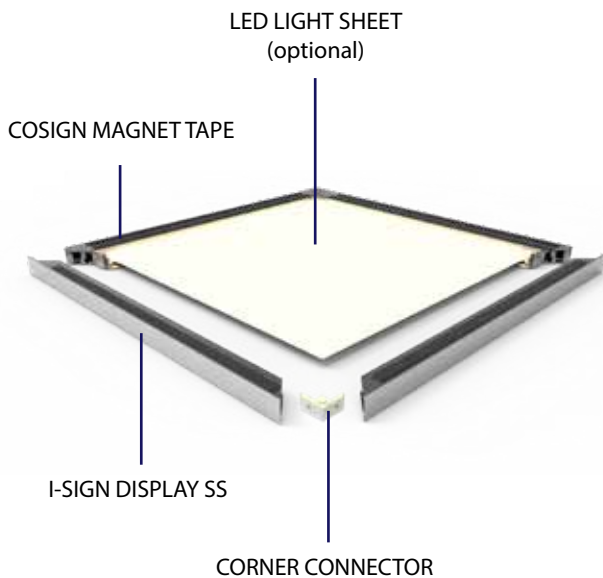

DOUBLE-SIDED SLIM

DUBBELSIDIG SLIMMAD

ALUMINIUM PROFILE / ALUMINIUMPROFILER

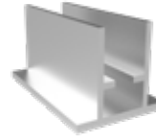

product code	description	
ID-SLIM1000	mill finish / mill	5m/l
ID-SLIM2000	anodised / anodiserad	5m/l

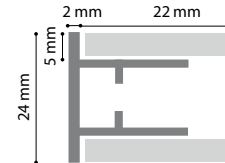

CORNER CONNECTOR / HÖRNFÄSTE



product code
ID-SL CORNER

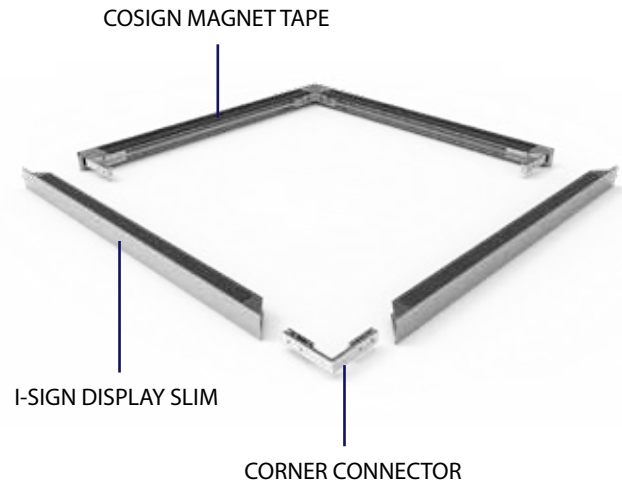

MAGNETIC STRIPS / MAGNETREMSOR



product code	description	
MAG12.7/1.5A5	isotropic A, 5 poles	12,7 x 1,5 mm
MAG12.7/1.5B5	isotropic B, 5 poles	12,7 x 1,5 mm
MAG25.4/1.5A9	isotropic A, 9 poles	25,4 x 1,5 mm
MAG25.4/1.5B9	isotropic B, 9 poles	25,4 x 1,5 mm
MAG12.7/1.0A5	anisotropic A, 5 poles	12,7 x 1 mm
METAL13	metal strip	13 x 0,22 mm
METAL25	metal strip	25 x 0,22 mm

DOUBLE-SIDED

DUBBELSIDIG

ALUMINIUM PROFILE / ALUMINIUMPROFILER



product code	description	
ID-DS1000	mill finish / mill	5m/l
ID-DS2000	anodised / anodiserad	5m/l
ID-DS5000	black anodised / svart anod.	5m/l

CORNER CONNECTOR / HÖRNFÄSTE



product code

ID-DS CORNER

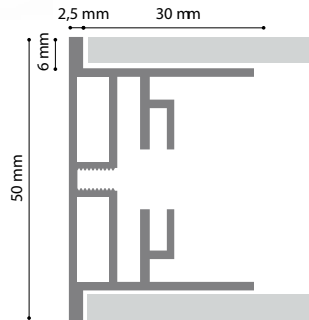

COSIGN MAGNET TAPE

LUCOLED EL31

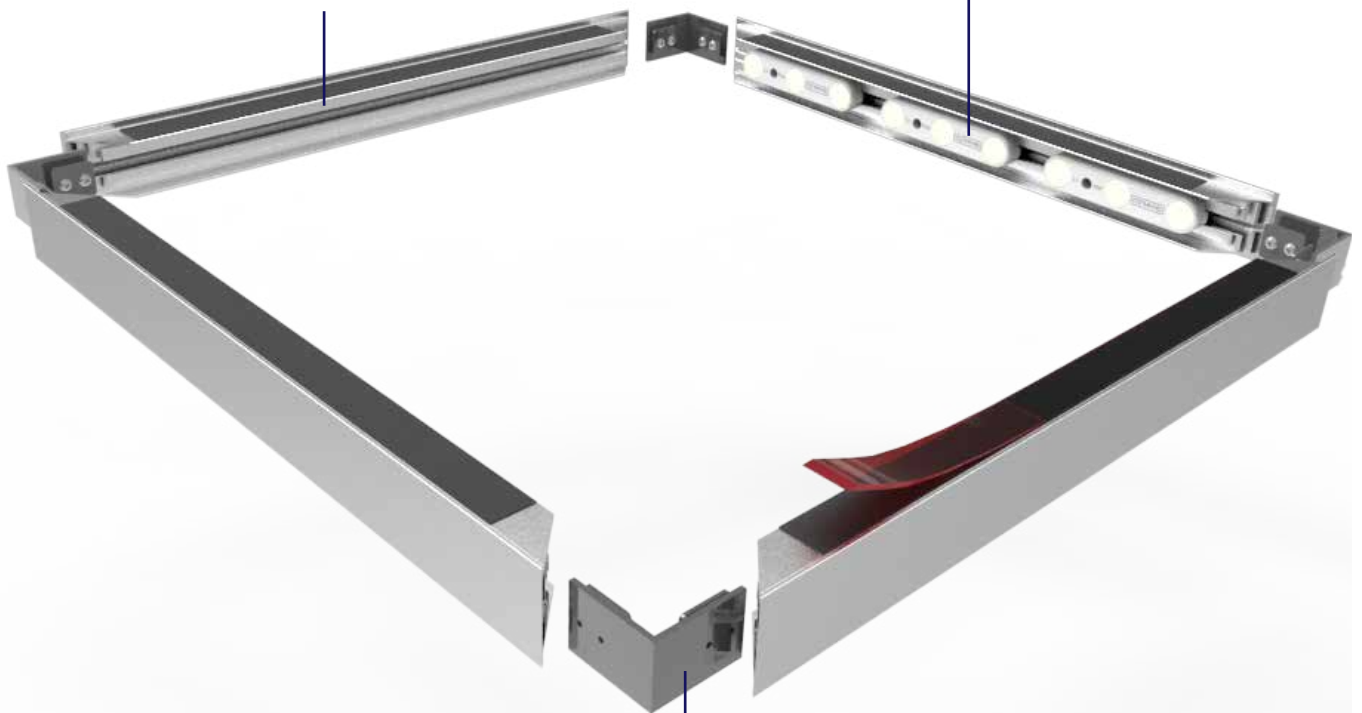

CORNER CONNECTOR



LUCOLED

Experience Lighting

LUCOLED EL31



product code	description
EL31-W65	12 VDC 327lm / module 2,88W / module

POWER SUPPLY / DRIVER



product code	description
PPS1230	Lucoled Slim 12 VDC / 30W
PPS1260	Lucoled Slim 12 VDC / 60W
PPS12100	Lucoled Slim 12 VDC / 100W
PP12150	Lucoled 12 VDC / 150W
PP12200	Lucoled 12 VDC / 200W

STRATO



www.cosign.nu

STRATO is a flexible and contemporary sign system consisting of a series of soft curved profiles with square sides.

A paper inlay (in the most common DIN formats) can be inserted in the profiles behind a non-reflecting acrylic cover. Other inserts in plastic or metal are of course also possible as well as direct signage or printing on the profiles.

The user can choose between plastic and aluminium end caps for the finish. Recently, a few profiles and end caps were added to the range that ensure that 400 mm, 500 mm and 600 mm wide directories can be produced.

STRATO är ett flexibelt och gångbart skyltsystem som består av en serie svagt utbuktande, konvexa, skyltprofiler.

Ett ark med papper kan skjutas in mellan skyltprofilen och frontplasten, som är tillverkad i icke reflekterande akryl. Det finns standardmått på skyltarna som är anpassade efter DIN formaten (A-serien, tex A5, A4 osv). Naturligtvis kan man istället för frontplast och pappersinstick använda andra plast-, eller metallmaterial som man skjuter in i skyltprofilen. En annan variant är att montera skyltbudskapet i form av skuren folie eller en printad dekal direkt på skyltprofilen.

Förutom skyltprofilen i aluminium och frontplasten så behövs sidostycken antingen i aluminium eller plast för att färdigställa skylten. Förutom de mest vanliga formaten finns det numera profiler och sidostycken så att man kan göra skyltar så breda som 400mm, 500mm och 600mm.



För information på svenska, besök www.cosign.nu/h/category.html/strato

PROFILES & ACCESSORIES

CUSTOM MADE

READY MADE

STANDARD SIZES / STANDARDSTORLEKAR

WALL MOUNTED VÄGGMONTERADE



product code	insert (h x w) in mm / instick (h x l) i mm		
ST-056074-W	53	x	74 (DIN A8)
ST-056105-W	53	x	105
ST-056150-W	53	x	150
ST-056210-W	53	x	210
ST-056297-W	53	x	297
56mm			
ST-078105-W	74	x	105 (DIN A7)
ST-078150-W	74	x	150
ST-078210-W	74	x	210
ST-078297-W	74	x	297
ST-078420-W	74	x	420
78mm			
ST-109105-W	105	x	105
ST-109150-W	105	x	150 (DIN A6)
ST-109210-W	105	x	210
ST-109297-W	105	x	297
ST-109420-W	105	x	420
109mm			
ST-150105-W	148	x	105 (DIN A6)
ST-150150-W	148	x	150
ST-150210-W	148	x	210 (DIN A5)
ST-150297-W	148	x	297
ST-150420-W	148	x	420
150mm			
ST-212148-W	210	x	148 (DIN A5)
ST-212210-W	210	x	210
ST-212297-W	210	x	297
ST-212420-W	210	x	420
212mm			
ST-300210-W	297	x	210 (DIN A4)
ST-300420-W	297	x	420 (DIN A3)
ST-300600-W	297	x	600
300mm			

PROJECTED UTSTICKANDE



product code	insert (h x w) in mm / instick (h x l) i mm		
ST-109148-P	105	x	148 (DIN A6)
ST-109210-P	105	x	210
109mm			
ST-150150-P	148	x	150
ST-150210-P	148	x	210 (DIN A5)
ST-150297-P	148	x	297
150mm			
ST-212210-P	210	x	210
ST-212297-P	210	x	297 (DIN A4)
212mm			

TABLE STAND BORDSSTÅENDE



product code	insert (h x w) in mm / instick (h x l) i mm		
ST-078105-T	74	x	105 (DIN A7)
ST-078150-T	74	x	150
78mm			
ST-109075-T	105	x	74
ST-109148-T	105	x	148 (DIN A6)
ST-109210-T	105	x	210
ST-109297-T	105	x	297
109mm			

SUSPENDED HÄNGANDE



product code	insert (h x w) in mm / instick (h x l) i mm		
ST-109210-S	105	x	210
ST-109297-S	105	x	297
ST-109420-S	105	x	420
ST-109600-S	105	x	600
109mm			
ST-150297-S	148	x	297
ST-150420-S	148	x	420
ST-150600-S	148	x	600
ST-150840-S	148	x	840
150mm			
ST-212297-S	210	x	297
ST-212420-S	210	x	420
ST-212600-S	210	x	600
ST-212840-S	210	x	840
212mm			

SUSPENDED MULTI-LEVEL HÄNGANDE I FLERA NIVÅER











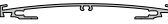

product code	insert (h x w) in mm / instick (h x l) i mm		
ST-109210-SD	105	x	210
ST-109297-SD	105	x	297
ST-109420-SD	105	x	420
ST-109600-SD	105	x	600
109mm			
ST-150297-SD	148	x	297
ST-150420-SD	148	x	420
ST-150600-SD	148	x	600
ST-150840-SD	148	x	840
150mm			
ST-212297-SD	210	x	297
ST-212420-SD	210	x	420
ST-212600-SD	210	x	600
ST-212840-SD	210	x	840
212mm			
STRATOCON-2	Connectors / Connectors (2pcs)		
STRATOCON-4	Connectors / Connectors (4pcs)		

Example suspended system / Exempel på hängande skyltlar (ovan) 150 x 600mm, 2 levels/2 nivåer:
ST-150600-S + STRATOCON-2 + ST-150600-SD





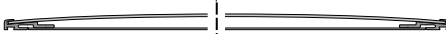



PROFILES & ACCESSORIES / PROFER & TILLBEHÖR

ALUMINIUM PROFILES ALUMINIUMPROFILER















	product code	profile	insert (hwx) / instick (lxh)	
	STRATO 2 0A8	56mm	DIN A8 (53mm)	5m/l
	STRATO 2 0A7	78mm	DIN A7 (74mm)	5m/l
	STRATO 2 0A6	109mm	DIN A6 (105mm)	5m/l
	STRATO 2 0A5	150mm	DIN A5 (148mm)	5m/l
	STRATO 2 0A4	212mm	DIN A4 (210mm)	5m/l
			DIN A3 (297mm)	5m/l
	STRATO 2 0A3S	edge profile / kantprofil		5m/l
	STRATO 2 0A3M	mid profile / mellanprofil		5m/l
		all sizes / alla storlekar		
	STRATOBS20	universal edge profile universell kantprofil		5m/l

PLASTIC ENDCAPS SIDSTYCKEN I PLAST

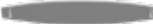
	product code	description
	STRATOCAP3A8	A8, black / svart
	STRATOCAP3A7	A7, black / svart
	STRATOCAP3A6	A6, black / svart
	STRATOCAP3A5	A5, black / svart
	STRATOCAP3A4	A4, black / svart
	STRATOCAP3A3	A3, black / svart

2. grey/grå 3. black/svart

ALUMINIUM ENDCAPS ALUMINIUMSIDSTYCKEN

	product code	description
	STRALUCAPA8	A8 single-sided / enkelsidig
	STRALUCAPA8D	A8 double-sided / dubbelsidig
	STRALUCAPA7	A7 single-sided / enkelsidig
	STRALUCAPA7D	A7 double-sided / dubbelsidig
	STRALUCAPA6	A6 single-sided / enkelsidig
	STRALUCAPA6D	A6 double-sided / dubbelsidig
	STRALUCAPA5	A5 single-sided / enkelsidig
	STRALUCAPA5D	A5 double-sided / dubbelsidig
	STRALUCAPA4	A4 single-sided / enkelsidig
	STRALUCAPA4D	A4 double-sided / dubbelsidig
	STRALUCAPA3	A3 single-sided / enkelsidig
	STRALUCAPA3D	A3 double-sided / dubbelsidig
	STRALUCAP400	400mm single-sided / enkelsidig
	STRALUCAP500	500mm single-sided / enkelsidig
	STRALUCAP600	600mm single-sided / enkelsidig

DIRECTORY / STANDARD REGISTERSKYLT

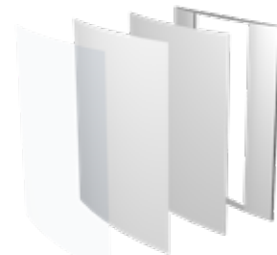

Directory example / Exempel (ovan) 400x600mm:
2x STRATO20A3S + 2x STRALUCAP400

VÄGGMONTERADE WALL MOUNTED

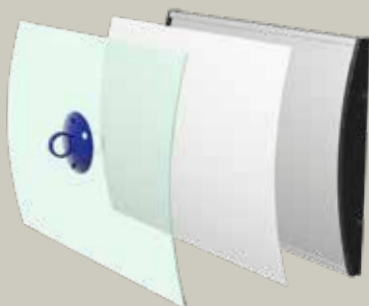

HÄNGANDE SUSPENDED

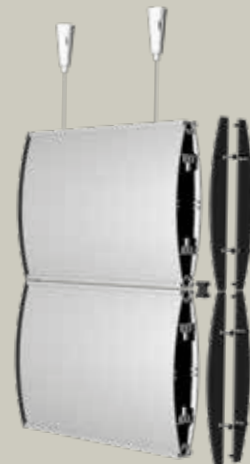

ACCESSORIES / ACCESSOARER

TABLE STAND / BORDSTÅENDE



product code	description
STRATOTS3A7	A7 black / svart
STRATOTS3A6	A6 black / svart
STRATOTS3UNI	universal black / universal svart

↳ 2. grey/grå 3. black/svart

PROJECTING BRACKET VÄGGFÄSTEN FÖR UTSTICKANDE SKYLTT



product code	description
STRATOBACRA6	A6 anodised / anodiserad
STRATOBACRA5	A5 anodised / anodiserad
STRATOBACRA4	A4 anodised / anodiserad

ANTI-REFLEX PET STRIPS ANTI-REFLEX, SKYDDSPLAST



product code	description
STRATOSTRIP8	1250 x 52,5 x 0,6mm
STRATOSTRIP7	1250 x 74 x 0,6mm
STRATOSTRIP6	1250 x 106 x 0,6mm
STRATOSTRIP5	1250 x 147,5 x 0,6mm
STRATOSTRIP4	1250 x 209,5 x 1mm
STRATOSTRIP3	1250 x 297 x 1mm

ALUMINIUM SLIDER PROFILE / SLIDERPROFIL I ALUMINIUM

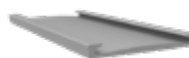

product code	description
SLIDERRCS	slider profile, 2,5m sliderprofil 2,5m

SCREWS / SKRUV



product code	description
SCREW003	↳ 2. grey/grå 3. black/svart

HANGING CLIP / KLIPPS, HÄNGANDE SKYLTLAR



product code	description
APC3000S	

CONNECTOR / CONNECTOR



product code	description
STRATOCON3	

HANGING KIT /VAJERKITT



product code	description
APC4101	2x conical clip + 1,5m wire 2x koniska takfästen + 1,5m vajer

UTSTICKANDE PROJECTED

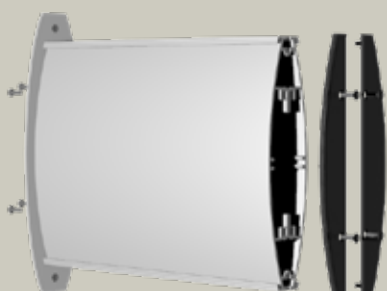

BORDSTÅENDE TABLE STAND



CURVO PLUS



www.cosign.nu

Curvo Plus is a modern, indoor sign system made from high-quality aluminium and executed in a stylish design with gently curved profiles and rounded corners.

The tabs with a stainless steel look keep the signs and the anti-reflective covers in place and give the signs extra cachet.

Moreover, the tabs are the same for all profiles. This limits the number of components and simplifies installation. It is possible to inscribe or print directly on the profiles.

För information på svenska,
besök www.cosign.nu/h/category.html/curvo





Curvo Plus är ett modernt skyltsystem för inomhusbruk, tillverkat i högkvalitativ aluminium. Curvo skyltarna har en stilren, modern design med svagt konvex profil och runda hörn.

Skylten och frontplaten hålls ihop av fästen i rostfritt stål som bidrar till helhetsintrycket av skylten.

Fästena är dessutom samma till alla profilerna i skyltserien. Allt för att minska antalet komponenter och förenkla ihop monteringen av skyltarna.

STANDARD SIZES / STANDARDSTORLEKAR

WALL MOUNTED VÄGGMONTERADE



product code	insert (wxh) in mm / instick (lxh) i mm		
CV-104150-W	89	x 150	104mm
CV-104210-W	89	x 210	
CV-104297-W	89	x 297	
CV-104420-W	89	x 420	
CV-134150-W	119	x 150	134mm
CV-134210-W	119	x 210	
CV-134297-W	119	x 297	
CV-134420-W	119	x 420	
CV-164105-W	149	x 105 (DIN A6)	164mm
CV-164150-W	149	x 150	
CV-164210-W	149	x 210 (DIN A5)	
CV-164297-W	149	x 297	
CV-164420-W	149	x 420	
CV-224150-W	210	x 150	224mm
CV-224297-W	210	x 297 (DIN A4)	
CV-312210-W	297	x 210 (DIN A4)	312mm
CV-312420-W	297	x 420 (DIN A3)	

PROJECTED UTSTÅENDE



product code	insert (wxh) in mm / instick (lxh) i mm		
CV-104090-P	89	x 90	104mm
CV-134120-P	119	x 120	134mm
CV-134240-P	119	x 240	
CV-164150-P	149	x 150	164mm
CV-164297-P	149	x 297	
CV-224210-P	210	x 210	224mm

SUSPENDED HÄNGANDE



product code	insert (wxh) in mm / instick (lxh) i mm		
CV-104420-S	89	x 420	104mm
CV-104600-S	89	x 600	
CV-134420-S	119	x 420	134mm
CV-134600-S	119	x 600	
CV-164150-S	149	x 150	164mm
CV-164297-S	149	x 297	
CV-164600-S	149	x 600	
CV-164840-S	149	x 840	
CV-224297-S	210	x 297	224mm
CV-224600-S	210	x 600	
CV-224840-S	210	x 840	

TABLE STAND BORDSSTÅENDE



product code	insert (wxh) / instick (lxh) i mm		
CV-164074-T	149	x 74	164mm
CV-164105-T	149	x 105 (DIN A6)	
CV-224074-T	210	x 74	224mm
CV-224105-T	210	x 105	

SUCTION CUP SUGPROPP



product code
VACUUMC2

WALL MOUNTED VÄGGMONTERADE

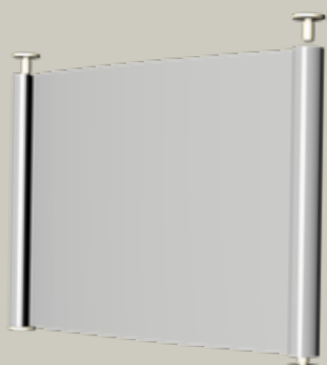







SUSPENDED HÄNGANDE





PROFILES & ACCESSORIES / PROFILER & TILLBEHÖR





ALUMINIUM PROFILES ALUMINIUMPROFILER

	product code	profile	insert (wxh) / instick (lxh) i mm	
	CURVO 2 090	104mm	89mm	5m/l
	CURVO 2 120	134mm	119mm	5m/l
	CURVO 2 150	164mm	149mm	5m/l
	CURVO 2 210	224mm	210mm (DIN A4)	5m/l
	CURVO 2 297	312mm	297mm (DIN A3)	5m/l
				
	CURVO BS20	universal side profile universal sidoprofil		5m/l

TABS / FÄSTEN

	product code	description
	TAB001	inox-look / inox-look
	TAB002	baseplate / basplatta + 2x TAB002





ALUMINIUM ENDCAPS ALUMINIUMSIDSTYCKEN

	product code	description
	CURCAP90	90mm double-sided / dubbelsidig
	CURCAP120	120mm double-sided / dubbelsidig
	CURCAP150	150mm double-sided / dubbelsidig
	CURCAP210	210mm double-sided / dubbelsidig

INOX STANDARD INOX, ROSTFRITT, STANDARD

	product code
	CURVOTS

PROJECTING BRACKET FLAGGSKYLTSFÄSTEN

	product code	description
	CURBRAC90	support / support: 90mm
	CURBRAC120	support / support: 120mm
	CURBRAC150	support / support: 150mm
	CURBRAC210	support / support: 210mm

HANGING KIT / VAJER KITT

	product code	description
	APC4101	2x conical clip + 1,5m wire 2x koniskt takfäste + 1,5m vajer

ANTI-REFLEX PET STRIPS ANTI-REFLEX, SKYDDSPLAST

	product code	description
	STRIP89	1250 x 89 x 0,6mm
	STRIP119	1250 x 119 x 0,6mm
	STRIP149	1250 x 149 x 1mm
	STRIP209	2050 x 209 x 2mm
	STRIP297	2050 x 297 x 2mm

PROJECTED UTSTICKANDE

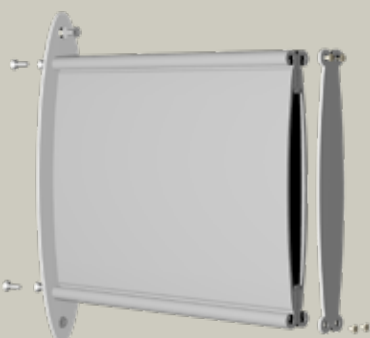

TABLE STAND BORDSSTÅENDE



MODULE PLUS INDOOR



www.cosign.nu

A CLASSIC PRODUCT THAT CONTINUES TO DO THE JOB PERFECTLY!

With the Module Plus Indoor, Cosign developed a modular sign system at the beginning of the 1990s that started a new trend within architectural signage and served as an inspiration for many of our colleagues.

The Module Plus Indoor consists of a series of flat aluminium profiles in different widths that has a 15,5 mm and 31 mm module as the basic profiles. The profiles can be "clicked" into place in an easy manner on plastic end caps or clips to create door signs, pictograms, directories, etc. Single-sided signs for wall mounting and double-sided systems for hanging or flag mounting are possible.

The Module Plus Indoor platform does not just offer the sign maker a simple, versatile and flexible standard solution, it also offers space to the creative sign maker to place his or her own emphasis and to develop customised products.

För mer information på svenska,
besök www.cosign.nu/h/category.html/module-plus





Paks Város Rendelőintézet

FÖLDSZINT

SEBÉSZET		NŐGYÓGYÁSZAT		RÖNTGEN - U	
01	Endoszkópos vizsgáló	F.21	Nőgyógyászat I.	F.12	Röntgen I. - F
02	Gipszelő	F.22	Nőgyógyászat II.	F.15	Röntgen II. - F
03	Sebészet	F.24	Terhes ambulancia	F.17	Administráció
	Műtő			F.18	Ultrahang
10	Sterilizáló				

EMELET

SZAKRENDELÉSEK			LABORATÓRIUM		
02	Ortopédia	I.05	Belgyógyászat	I.10	Vérételt labor
02	Gyermek pulmonológia	I.05	Sportorvos		Kémiai labor
02	Urológia	I.06	Reumatológia Oszteoporózis		Hematológia
03	Kardiológia	I.07	Szemészet		Vizelet labor
04	Gasztroenterológia	I.08	Fül-orr-gégészet		Hűtőszoba
			IGAZGATÓSÁG		
6	Gazdasági iroda	I.14	Igazgatók	I.14	Vezető osztály

EMELET

01	Könyvtár				
----	----------	--	--	--	--



EN BEPRÖVAD KLASSISK PRODUKT SOM FORTSÄTTER ATT GÖR JOBBET UTMÄRKT!

Module Plus Indoor, kom på 1990 talet när Cosign bestämde sig för att ta fram ett modulärt skyltsystem. Module Plus har med tiden kommit att inspirera många andra kollegor i skylt branschen.

Module Plus Indoor består av en serie aluminiumprofiler som kan kapas i önskad längd. Aluminiumprofilerna, även kallade paneler eller lameller, finns i ett gäng standardhöjder, från 15,5 mm och uppåt. Dessa paneler kan klickas ihop med hjälp av sidostycken i plast eller aluminium och därigenom skapa t.ex. dörrskyltar, hänvisningsskyltar, orienteringstavlor m.m.

Förutom enkelsidiga skyltar för väggmontering, finns det även lösningar för dubbelsidiga hängande skyltar och flaggskyltar.

Module Plus Indoor systemet erbjuder inte bara en enkel, mångsidig lösning, utan möjliggör också för den kreativa skyltmakaren att sätta sin egen präglning på skyltarna och göra egna specialanpassningar.



PROFILES & ACCESSORIES / PROFILER & TILLBEHÖR

ALUMINIUM TEXT PROFILES TEXTPROFILER I ALUMINIUM

product code	profile
ANO 1 300	300 mm mill finish / mill 5m/l
ANO 1 250	250 mm mill finish / mill 5m/l
ANO 1 187	187 mm mill finish / mill 5m/l
ANO 1 156	156 mm mill finish / mill 5m/l
ANO 1 125	125 mm mill finish / mill 5m/l
ANO 1 093	93 mm mill finish / mill 5m/l
ANO 1 062	62 mm mill finish / mill 5m/l
ANO 1 046	46,5 mm mill finish / mill 5m/l
ANO 1 031	31 mm mill finish / mill 5m/l
ANO 1 015	15,5 mm mill finish / mill 5m/l

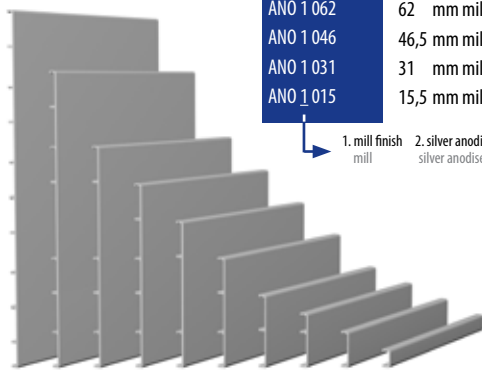

300 250 187 156 125 93 62 46,5 31 15,5 mm

1. mill finish mill 2. silver anodised silver anodiserad 3. color färg 4. gold anodised guld anodiserad

ALUMINIUM SLIDER PROFILE SLIDERPROFIL I ALUMINIUM

product code	profile profil	insert instick	thickness tjocklek
ASO 1 093	93 mm	89,5 mm	≤1,6 mm
ASO 1 062	62 mm	58 mm	≤1,6 mm
ASO 1 046	46,5 mm	42,5 mm	≤1,2 mm
ASO 1 031	31 mm	27 mm	≤1,0 mm
ASO 1 015	15,5 mm	11,5 mm	≤1,0 mm



93 62 46,5 31 15,5 mm

ASO 1 031.SP	31 mm	custom	≤1,2 mm
--------------	-------	--------	---------

1. mill finish mill 2. silver anodised silver anodiserad 3. color färg 4. gold anodised guld anodiserad

SINGLE SIDED ENDCAPS ENKELSIDIGA SIDSTYCKEN

product code	description
APE 3 250	250 mm black / svart
APE 3 218	218 mm black / svart
APE 3 187	187 mm black / svart
APE 3 156	156 mm black / svart
APE 3 125	125 mm black / svart
APE 3 093	93 mm black / svart
APE 3 062	62 mm black / svart
APE 3 046	46,5 mm black / svart
APE 3 031	31 mm black / svart
APE 3 015	15,5 mm black / svart

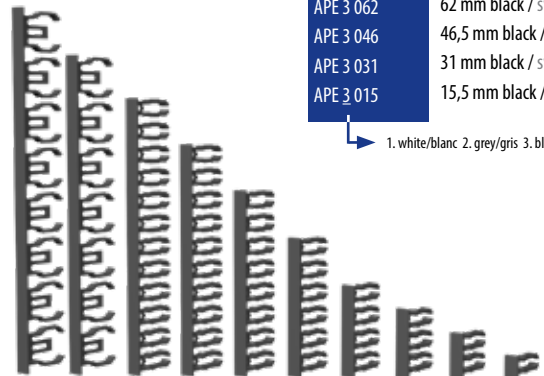

250 218 187 156 125 93 62 46,5 31 15,5 mm

1. white/blanc 2. grey/gris 3. black/noir

DOUBLE SIDED ENDCAPS DUBBELSIDIGA SIDSTYCKEN

product code	description
APD 3 300	300 mm black / svart
APD 3 250	250 mm black / svart
APD 3 187	187 mm black / svart
APD 3 156	156 mm black / svart
APD 3 125	125 mm black / svart
APD 3 093	93 mm black / svart
APD 3 062	62 mm black / svart

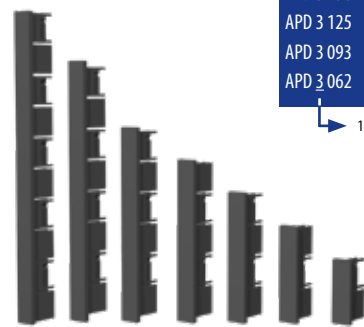

300 250 187 156 125 93 62 mm

1. white/vit 2. grey/grå 3. black/svart

WALL MOUNTED VÄGGMONTERADE

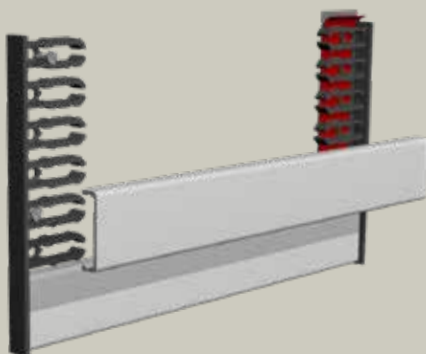

PROJECTED UTSTICKANDE

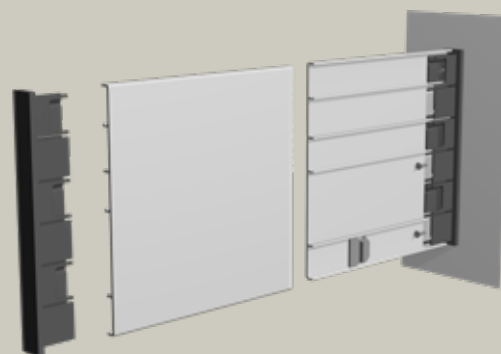

ACCESSORIES / ACCESSOARER

HANGING KIT / VAJERKITT



product code	description
APC4101	2x conical clip + 1,5m wire 2x koniska takfästen + 1,5m vajer



product code	description
APC 3 000	plastic suspension clip / klip i plast för hängande skyltar 2. grey/grå 3. black/svart



product code	description
APC 4 400	metal suspension profile / profil i metall, för hängande skyltar
APC 4 500	metal suspension clip / metal clip för hängande skyltar (30mm)



product code	description
APC 6 000	wedge ABS black / kil i ABS-plast, svart

SUCTION CUP SUGPROPP



product code
VACUUMC2
VACUUMC

KEY SKYLTVERKTYG



product code
APK1000

TABLE STAND BORDSSTÅENDE



product code	description
APC7000	wedge / kil



product code	description
APW 3 031	triangular endcap / triangulärt sidstycke 1. white/blanc 2. grey/gris 3. black/svart

product code	description
APW 3 062	triangular endcap / triangulärt sidstycke 62mm 2. grey/gris 3. black/svart

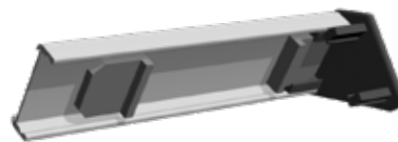

SUSPENDED HÄNGANDE

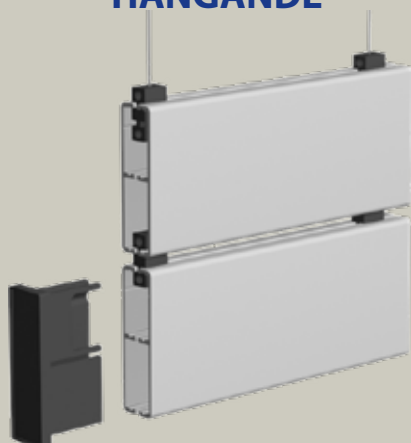
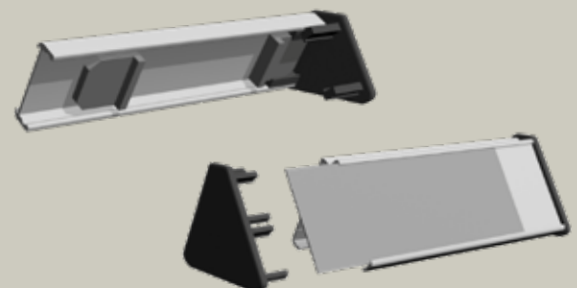
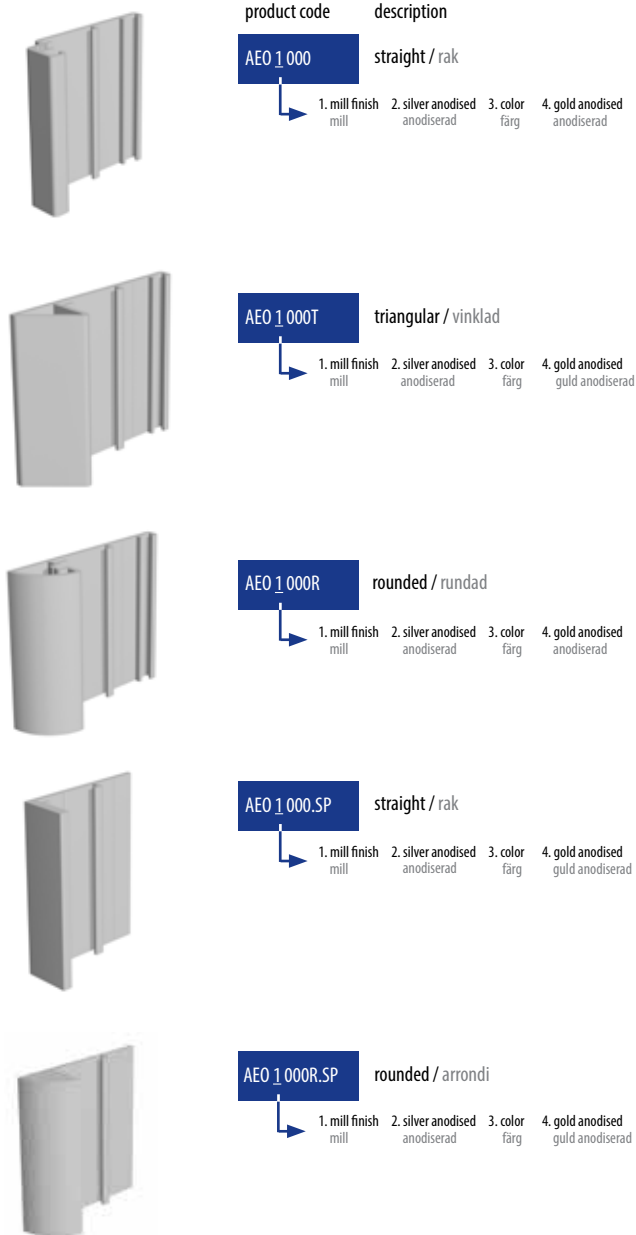

TABLE STAND BORDSTÅENDE



PROFILES / PROFILER

ALUMINIUM SIDE PROFILES ALUMINIUMPROFILER



SUPPORT / DIVIDER PROFILES STÖD- OCH AVDELANDEPROFILER

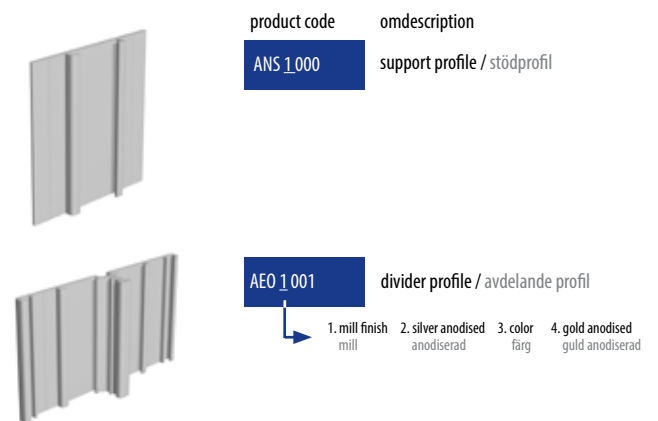

SIDE PROFILE COMBINATION SIDPROFILER, KOMBINATIONER

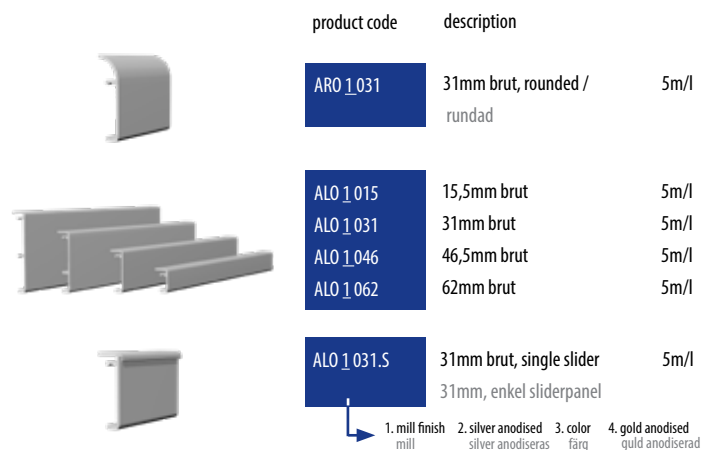

FRAME PROFILE RAMPROFIL

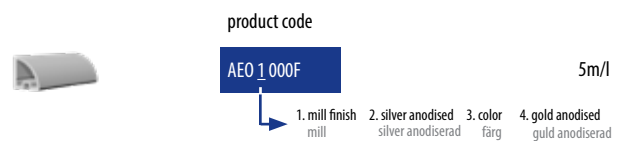

DIRECTORY REGISTERSKYLT

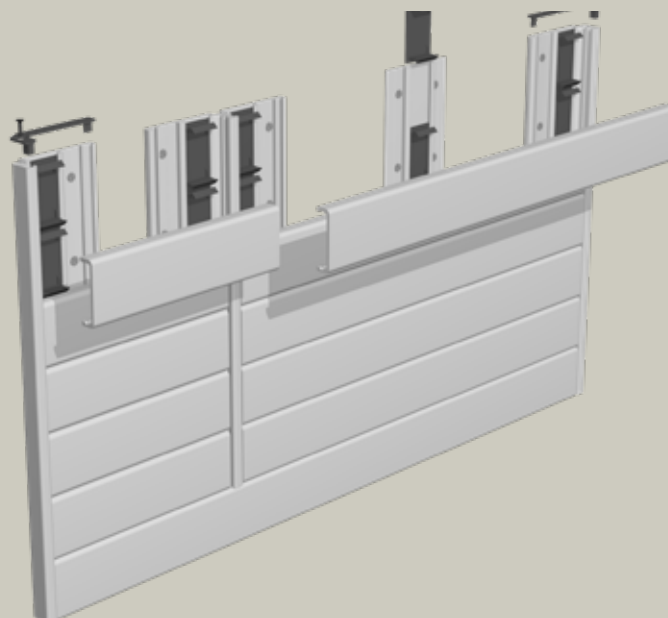

ACCESSORIES / ACCESSOARER

ENDCAPS FOR SIDE PROFILES TOPP- OCH BOTTEN LÅS FÖR SIDSTYCKEN



product code description
APT 3 000 straight / rak
 2. grey/grå 3. black/svart



product code description
APT 3 000B straight / rak
 2. grey/grå 3. black/svart



product code description
APT 3 000L rounded / rundad
 2. grey/grå 3. black/svart



product code description
APT 3 000T triangular / vinklad
 2. grey/grå 3. black/svart



product code description
APT 3 003R rounded / rundad
 2. grey/grå 3. black/svart



product code description
APT 3 006R for frame profile / för ramprofil
 2. grey/grå 3. black/svart

CLIPS FOR SIDE PROFILES CLIPS FÖR SIDPROFILER



product code description
APC 5000 clips 31mm
APC 5001 clips 15,5mm



product code description
APC5000LS clips 6x31mm

INTERIOR TOTEM TOTEM, INOMHUSBRUK



product code profile / profil
TOT 1 080.SP totem profile 5m/l
 totemprofil
 1. mill finish mill 2. silver anodised silver anodiserad 3. color färg



FLOORPLATE metal floorplate
 golvplatta i metall
 870mm x 200mm



TOPCOVER metal coverplate
 täckplatta i metall
 750mm x 80mm

INTERIOR TOTEM TOTEMSKYLTT FÖR INOMHUSBRUK

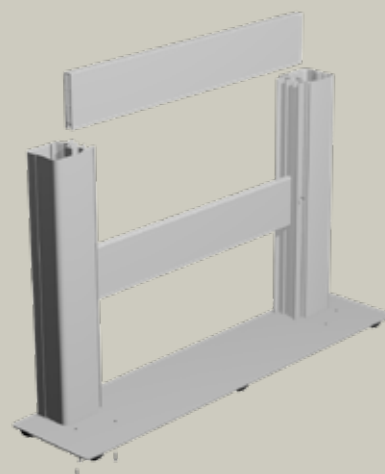
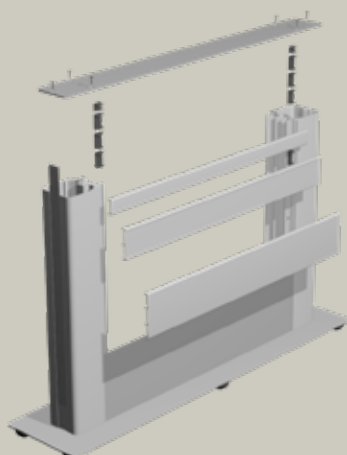

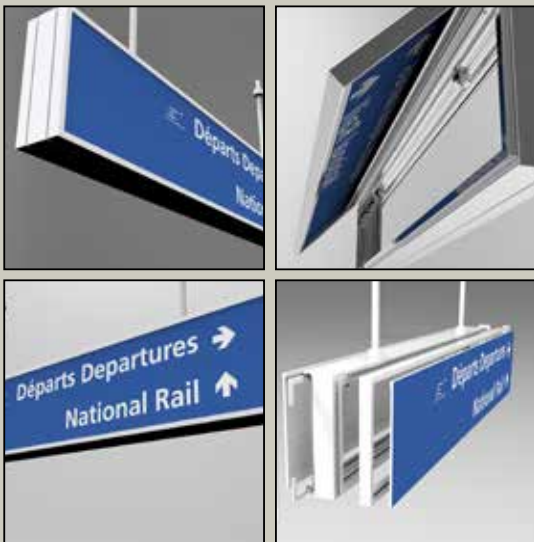

LIGHTBOX

HIGHLIGHT

COSIGN CONTINUES TO DEDICATE ITSELF TO LED SIGNS

LED lighting offers innumerable advantages when compared to traditional light sources. LEDs do not become hot, are energy efficient, safe, sustainable, maintenance free, environmentally friendly and have a long service life.

The developments in the LED industry are taking place at quick succession. Cosign is keeping a close eye on this evolution and, therefore, developed some innovative LED products such as LED THINLITE, SOLED and PROFILED. LED modules can also be used in our new I-SIGN DISPLAY profiles.

Cosign is underscoring its ambitions in the area of LED products by entering into a partnership with the American SloanLED, a trendsetter in LED technology and one of the largest manufacturers of qualitative LED modules for the sign industry in the world and by concluding a joint venture agreement with the British Applelec for the production and marketing of LED Light Sheets.

LED SIGNS

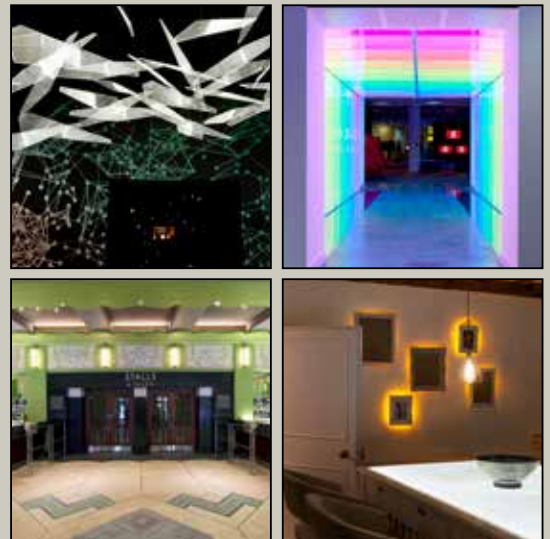

SOLED

LED LIGHT SHEET

COSIGN FOTSÄTTER ATT FOKUSERA PÅ LED-SKYLTLAR

LED-tekniken har ofantligt många fördelar jämfört med de gamla traditionella ljuskällorna. LED-dioderna blir inte lika varma, de är energisparande, säkra, hållbara, miljövänliga, underhållsfria och har en lång livslängd.

LED-tekniken fortsätter att utvecklas och förbättras kontinuerligt. Cosign håller givetvis ett öga på denna utveckling och har kommit med flera, nya, spännande LED-produkter, så som LED THINLITE, SOLED och PROFILED. Dessutom kan LED-moduler byggas in i I-SIGN DISPLAY-profilerna.

För att verkligen understryka sina ambitioner när det gäller LED-produkter har Cosign ingått ett partnerskap med amerikanska SloanLED. SloanLED är en trendsättare inom LED-teknologin och numera en av världens största tillverkare av högkvalitativa LED-moduler för skyltbranschen, efter att ha fattat en överenskommelse med brittiska Applelec gällande tillverkning och marknadsföring av LED Light Sheets.

LIGHTBOX



www.cosign.nu

Cosign developed an elegant indoor lightbox with a depth of only 75mm (single-sided) or 100mm (double-sided). The hinging frame on top makes maintenance and a quick change of the acrylic panels and/or graphics extremely easy.

The hinging frame comes in 2 versions. One has the typical I-Sign look with the thin edge. The other one has an edge of 12,5mm which allows for the acrylic panels to be fully illuminated. The perfect lightbox for airports, metro stations, garages etc ...

Cosign har utvecklat en elegant inomhusljustlåda med ett djup på endast 75mm (enkelsidig) eller 100mm (dubbelsidig). Ramkonstruktionen är öppningsbar i toppen vilket gör att underhåll samt byte av skyltbudskap blir extremt smidigt.

Den öppningsbara ramen kommer i två versioner. En har den typiska I-Sign looken med en tunn, slimmad kant. Den andra har en kant som är 12,5mm vars konstruktion gör att akrylfronten blir upplyst hela vägen ut till kanten. Detta är den perfekta skyltlösningen till flygplatser, tunnelbanestationer, garage mm.



PROFILES & ACCESSOARER / PROFILER & ACCESSOARER

ALUMINIUM PROFILES ALUMINIUMPROFILER



product code description
LB-BASE-DS10 base profile double sided
 basprofil, dubbelsidig
 1. mill finish 2. silver anodised
 mill silveranodiserad

6,1m/l



product code description
LB-BASE-SS10 base profile single sided
 basprofil, enkelsidig
 1. mill finish 2. silver anodised
 mill silveranodiserad

6,1m/l



product code description
LB-FRAME-N10 frame profile 12,5mm silver anodised
 ramprofil, 12,5mm, silveranodiserad

6,1m/l



product code description
LB-FRAME-I10 frame profile 1,5mm silver anodised
 ramprofil, 1,5mm, silver anodiserad

6,1m/l



product code description
LB-HINGE hinge profile mill finish
 gångjärnsprofil, mill finish

6,1m/l

ACCESSORIES / ACCESSOARER



product code description
LB-BASE-CORNER corner for base profiles
 hörn för basprofiler

6,1m/l



product code description
LB-FRAME-CORNER corner for frame profiles
 hörn för ramprofiler

6,1m/l



SINGLE SIDED - FRAME I ENKELSIDIG - RAM I

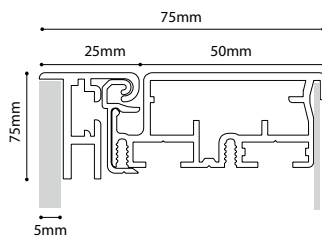

SINGLE SIDED - FRAME N ENKELSIDIG - RAM N

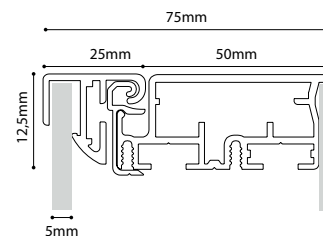

DOUBLE SIDED - FRAME I DUBBELSIDIG - RAM I

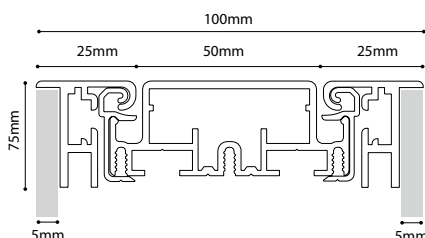

DOUBLE SIDED - FRAME N DUBBELSIDIG - RAM N

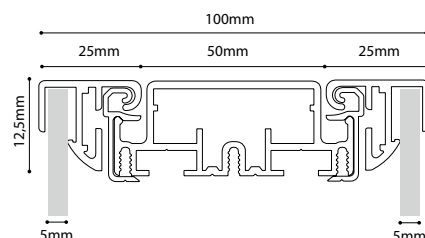

HIGHLIGHT



www.cosign.nu

Highlight is Cosign's new LED luminaire profile which, in combination with the LucoLed® HighLiner II modules or other LED modules, provides the perfect solution for creating decorative wall washers or illuminating large surfaces like billboards, advertising signs, freestanding signs and totem pylons.

The elliptical shaped aluminium profile is supplied including endcaps, a special LED diffusing opal polycarbonate cover, easy-to install wall brackets, spacer profiles and a hinge bracket which allows the profile to be set in the right angle to ensure an optimal light distribution.

Highlight är Cosign's nya LED-belysta profil som, i kombination med LucoLed® HighLiner II moduler eller andra LED-moduler, är den perfekta lösningen när man vill ljussätta väggar på ett dekorativt sätt, eller lysa upp större ytor så som billboards, annonsplaceringar, fristående skyltar och stora pyloner.

Den elliptiskt formade aluminiumprofilen levereras inklusive följande delar;

- sidostrycken,
- LED-diffuserande täcksiva i opal polykarbonat,
- lättmonterade väggfästen,
- distansprofiler,
- samt rörliga fästen så att få rätt vinkel på armaturen i förhållande till ytan man vill belysa.

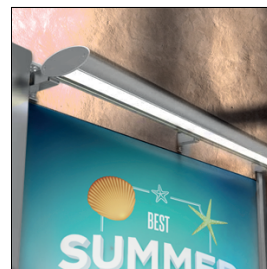
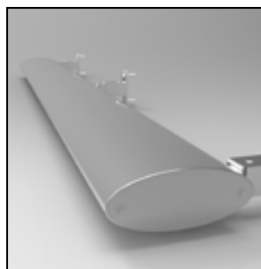

PROFILES & ACCESSORIES / PROFILER & ACCESSOARER

ALUMINIUM PROFILES ALUMINIUMPROFILER



product code description
HL-PROF 1 000 highlightprofile 6,1m/l
 highlightprofil
 1. mill finish 2. silver anodised
 mill silveranodiserad

ENDCAP / SIDSTYCKEN



product code description
HL-CAP 1 000 endcap / sidostycke
 1. mill finish 2. silver anodised
 mill silveranodiserad

WALL BRACKET / VÄGGFÄSTE



product code description
HL-WB 1 000 wall bracket / väggfäste
 1. mill finish 2. silver anodised
 mill silveranodiserad



COVER PROFILE / TÄCKPROFIL



product code omschrijving
HL-PC-OPAL Polycarbonate cover profile 6,1m/l

SPACER / DISTANSBITAR / MELLANBITAR



product code description
HL-SP 1 000 spacer 30x30x2mm 3m/l
 1. mill finish 2. silver anodised
 mill silveranodiserad

HINGE BRACKET / FÄSTE



product code description
HL-HB 1 000 hinge bracket
 1. mill finish 2. silver anodised
 mill silveranodiserad

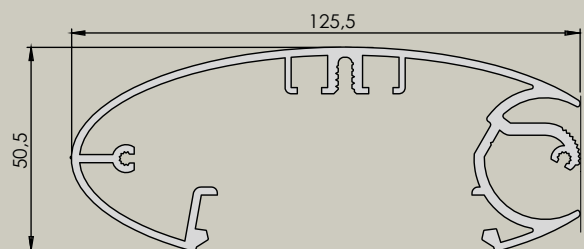
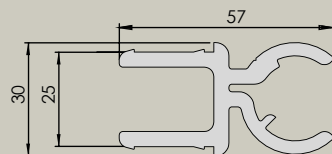
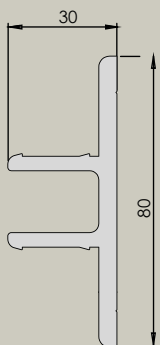
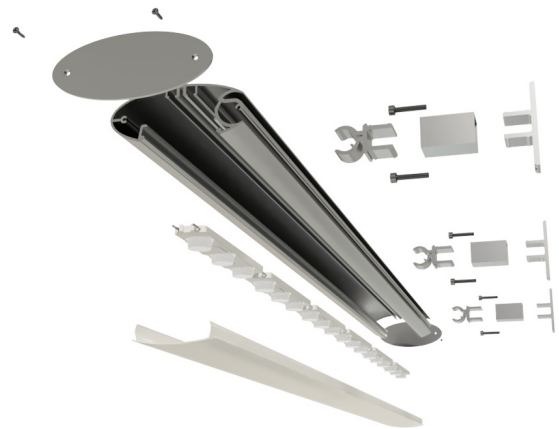

SOLED

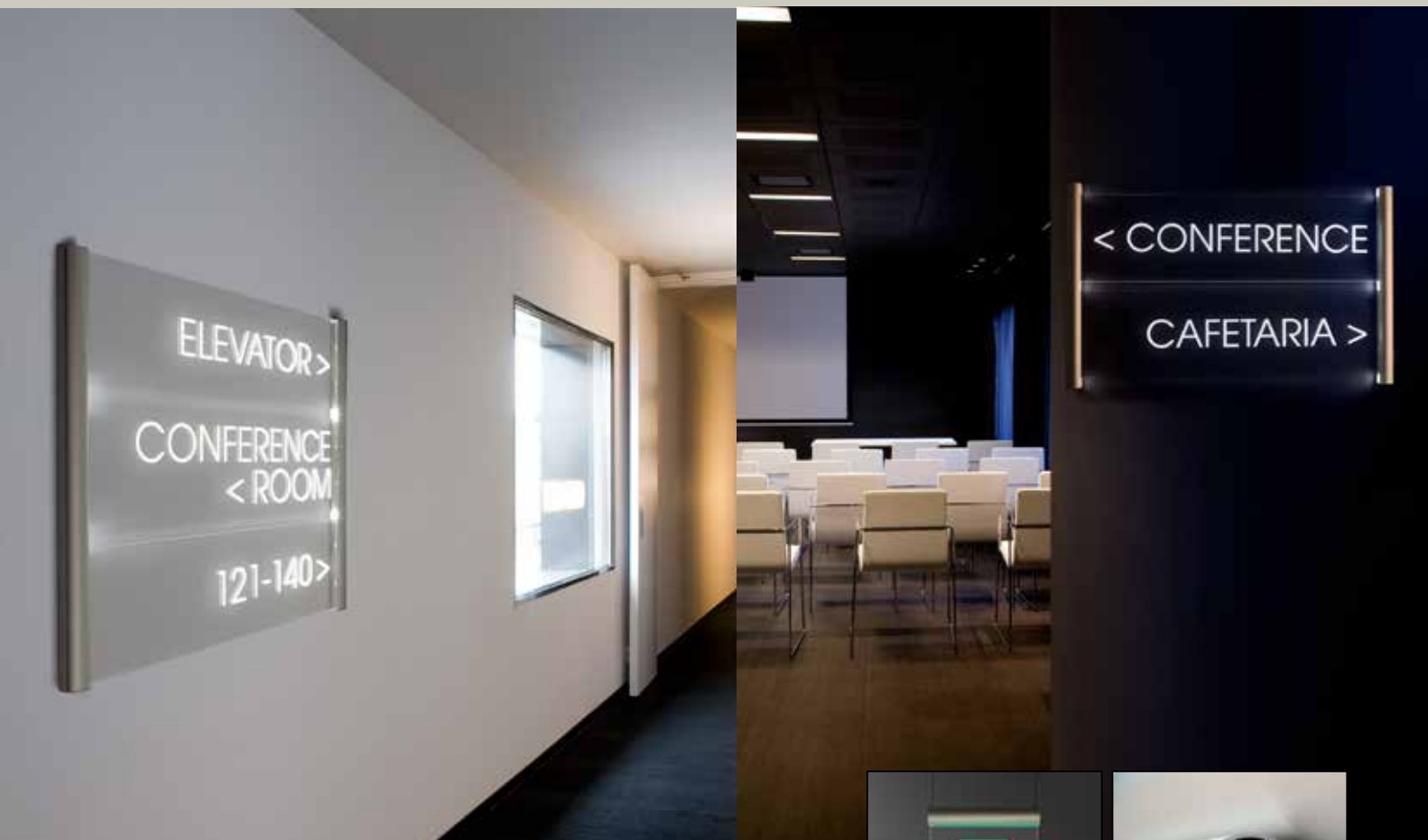

www.cosign.nu

SOLED is an architectural sign application where a LED strip is integrated into the profiles that ensures the light is introduced in a glass or acrylic sheet from the side. This ensures that the image on the front of the sheet is lit up. The image can easily be added to the sheet using a film or it can be engraved into the sheet.

SOLED is a modular system where the customer can choose between a round, curved or square profile and where the signs can be wall mounted, suspended or flag mounted.

SOLED är ett skyltsystem med ett arkitektoniskt uttryck. En typisk SOLED skylt har en aluminiumprofil med integrerad LED, i form av en s.k. LED-strip, vars uppgift är att lysa upp en glas-, eller akrylskiva, från kanten. Med denna konstruktion kan man få en bild eller text på framsidan av den belysta skivan att lysa. Motivet man vill belysa kan lämpligtvis vara printad på transparent film eller gravas direkt in i skivan.

SOLED är ett modulärt system där kunden kan välja mellan rund, elliptiskt eller kvadratisk aluminiumprofil, samt om skylten ska vara väggmonterad, nedpendlad från tak eller utstickande från vägg.



PROFILES & ACCESSORIES / PROFILER & ACCESSOARER

ALUMINIUM PROFILES ALUMINIUMPROFILER

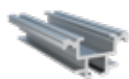

product code profile / profilé
SOL_1000.B base / basprofil 5m/l



SOL_1000.R round / rund 5m/l



SOL_1000.C ellipse / elliptisk 5m/l



SOL_1000.S square / rektangulär 5m/l
 1. mill finish minn 2. silver anodised silveranodiserad

ALUMINIUM ENDCAPS ALUMINIUMSIDSTYCKEN



product code description
SOLCAP08.R round / rund (8mm)



SOLCAP12.R round / rund (12mm)



SOLCAP08.C ellipse / elliptisk (8mm)



SOLCAP12.C ellipse / elliptisk (12mm)

SOLCAP08.S square / kvadratisk (8mm)

SOLCAP12.S square / kvadratisk 12mm)

SOLCAP08.SC combined / kombinerad (8mm)

SOLCAP12.SC combined / kombinerad (12mm)

PROJECTING BRACKET FÄSTE FÖR UTSTICKANDE SKYLTT



product code description
SOLBRAC08 for plates 8mm / Fäste för 8mm
SOLBRAC12 for plates 12mm / Fäste för 12mm

HANGING CLIP / CLIP TILL VAJER



product code
APC3000S

HANGING KIT / VAJERKIT



product code description
APC4101 2x conical clip + 1,5m wire
 2x koniska takfästen + 1,5m vajer

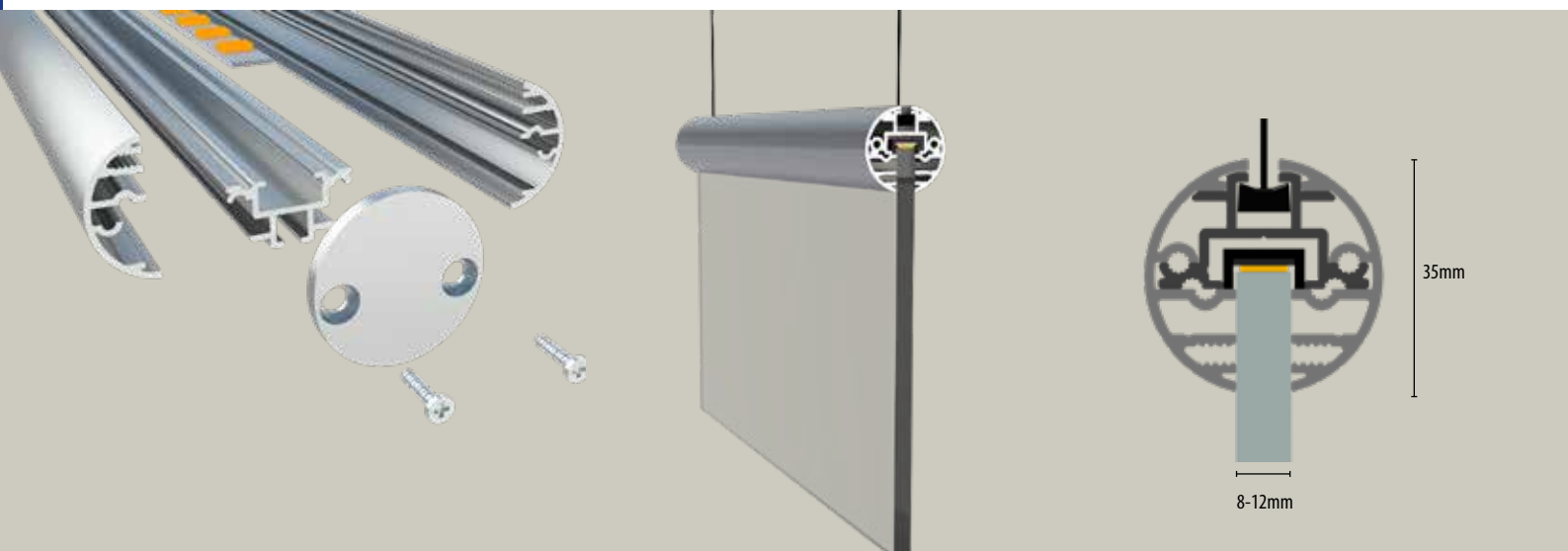

LED LIGHT SHEETS



LED Light Sheets are thin acrylic sheets with embedded LEDs. The specific composition of the product as well as adding an optical pattern with the patented V-cut technology or a personalised dot pattern with laser technology ensures a uniform distribution of light.

LED Light Sheets can be supplied in all sizes and shapes with white LEDs in various colour temperatures or with RGB LEDs. LED Light Sheets are mainly used indoors and in display and sign projects where the available space/depth to integrate a source of light is limited.

LED Light Sheets är tunna akrylskivor med inbäddad LED. Produktens specifika uppbyggnad och sammansättning, tillsammans med det optiska mönster som graveras in i skivan, antingen med patenterad V-cut teknologi, eller med ett kundanpassat laserpunktmönster, gör att ljuset får en jämn fördelning över hela skivan.

LED Light Sheets kan levereras i alla storlekar och former, inklusive vit LED i olika färgtemperaturer, eller RGB LED om så önskas. LED Light Sheets är en inomhusprodukt och lämplig till display-, inrednings- och skyltprojekt där utrymmet för att få plats med belysning är begränsat.

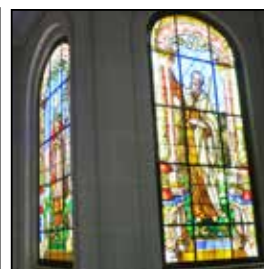

TECHNICAL SPECIFICATIONS / TEKNISKA SPECIFIKATIONER

Material Material	Acrylic / Akryl (PMMA)
Thickness Tjockhet	6mm, 8mm, 10mm (RGB Leds / LED RGB)
Pattern Motiv/mönster	V-cut optical pattern / Optiskt mönster, V-cut (1,4mm - 2,8mm - 5,6mm) Laser dot pattern (personalised) Laserpunktmönster (personaliserad)
Max. size Maxdimensioner	3000mm x 1500mm
LED	5630 SMD LED (0,25W P=15mm)
Input voltage Spänning in	AC 100 - 240V 50/60Hz
Operating voltage Driftspänning	DC 12V - 24V
Efficiency Effektivitet	120lm / W
Colour temperature Färgtemperatur	3000K, 3700K, 4100K, 5300K, 6000K, 6500K, RGB
CRI Färgåtergivningsindex	65 - 90
Degree of protection Klassificering	IP54 - IP67
Service life Livsläng	>50.000 uur (L ₇₀)
Guarantee Garanti	LED Light Sheets (3 years / 3 år) - acrylic / Akryl (5 years / 5 år)
Operating temperature Driftstemperatur	-30°C tot +40°C -30°C tom +40°C
Accessories Accessoarer	Power supplies, connectors, splitters, RGB drivers, dimmers. Ettillbehör, connectors, splitters, RGB drivers, dimrar.



TEXTILE FRAME



COSIGN TEXTILE FRAMES: INFINITE POSSIBILITIES

Textile frames are the solution for the fast and easy exchange of printed textile fabrics. The image is printed on a textile fabric and a silicon beading is added around it. This is simply pressed into the profile that ensures that the slightly stretchable fabric can be stretched perfectly.

The convenience of use of our aluminium profiles in combination with innovative accessories and high-quality textile fabrics that can be printed up to 3 m wide seamlessly means that our textile frames are perfectly suitable for dressing and setting up shops, showrooms, offices and fair stands. Regardless of whether you want a wall frame or a standalone or hanging frame, you will find the right solution with our single- and double-sided textile profiles.

Cosign also offers LED profiles in which you can integrate High Power LED modules that will ensure that the fabric is lit up uniformly and the image is done even better justice. You can also include a noise-dampening material behind the printed fabric to improve the acoustics of a room or to create partitions.

You will not just find the profiles and accessories at Cosign, you can also order the full custom-made product including the printed fabric.



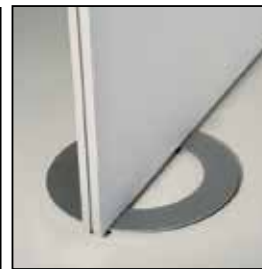
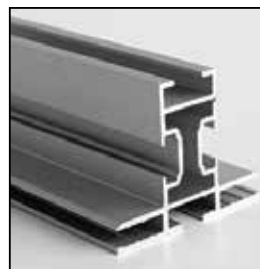

COSIGN TEXTILRAMAR: OÄNDLIGA MÖJLIGHETER





Cosign's textiliramar är lösningen för hur man snabbt och enkelt hanterar skyltning med, och byte av, printade textilier. Den printade textilväven förses med en silikonkant. Denna kant pressas sedan igenom aluminiumprofilen som ser till att väven blir perfekt spänd över hela ytan.

Textiliramarna är särskilt lämpade när man ska inreda och skylta upp butiker, showrum, kontor och mässmontrar. Detta tack vare smidigheten i att använda Cosign's aluminiumprofiler i kombination högkvalitativa textilvävar. Resultatet blir skarvlösa textilinstallationer som kan täcka stora ytor. Oavsett om du vill ha en vägghängd ram, en golvsstående ram, eller en ram nedpendlad från taket, så finns lösningen i Cosign's sortiment av enkel- och dubbelsidiga textil profiler.

Cosign erbjuder också LED-profiler, där man kan integrera s.k. "High Power LED moduler" i textilramen som lyser upp hela duken och gör rättvisa åt motivet. Man kan även inkludera ljuddämpande material bakom den printade duken för att förbättra akustiken i rummet. Ett annat användnings-område för en ljuddämpande textiliram är om man vill skapa rumsavdelare. Förutom profiler och tillbehör kan Cosign även erbjuda kundanpassade lösningar inklusive print på duk och LED-bestyckning.

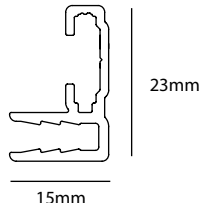
PROFILES / PROFILER

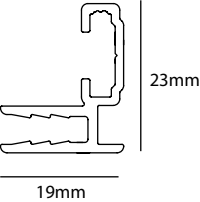
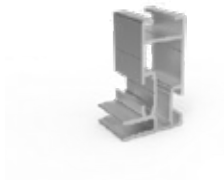
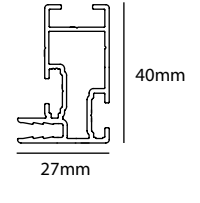
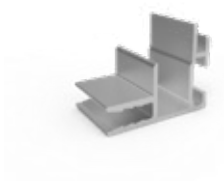
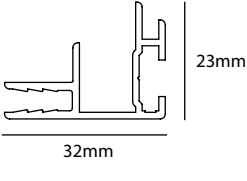
SINGLE-SIDED TEXTILE FRAME PROFILES / ENKELSIDIGA PROFILER FÖR TEXTILRAMAR

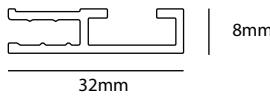



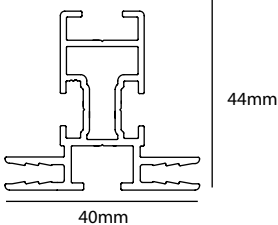
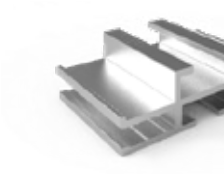
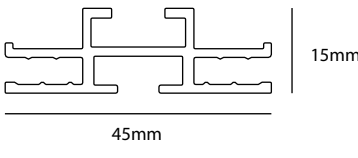

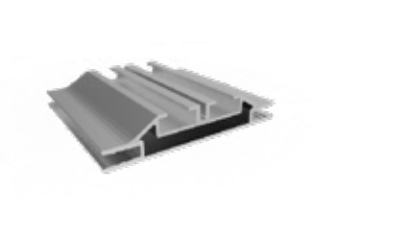
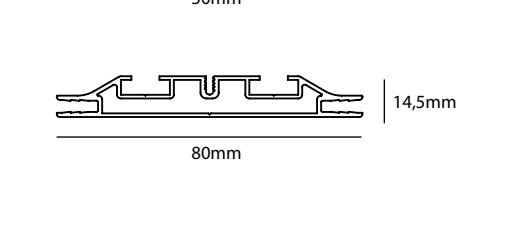
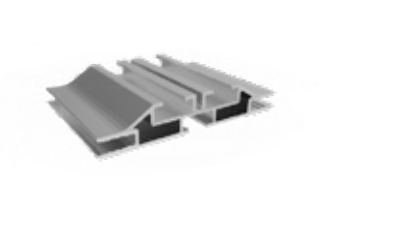
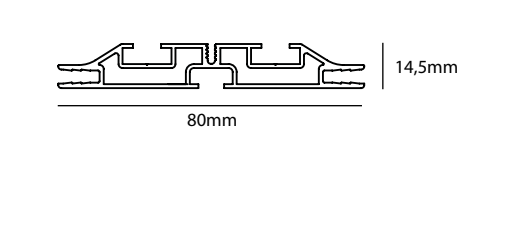
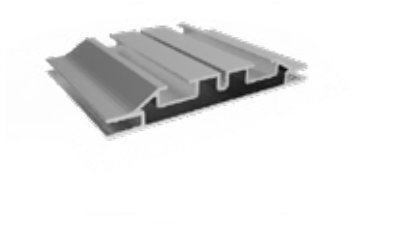
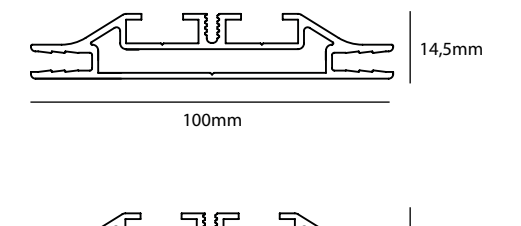

	product code	profile / profil			
	TEXSSLD15	15x23mm (light duty)	6,1mtr		23mm 15mm
	TEXSSLD19	19x23mm (light duty)	6,1mtr		23mm 19mm
	TEXSSHD27	27x40mm (heavy duty)	6,1mtr		40mm 27mm
	TEXLLS32	32x23mm (Led Light Sheet)	6,1mtr		23mm 32mm
	TEXNICHE	32x8mm (niche)	3mtr		8mm 32mm

DOUBLE-SIDED TEXTILE FRAME PROFILES / DUBBELSIDIG PROFIL FÖR TEXTILRAMAR

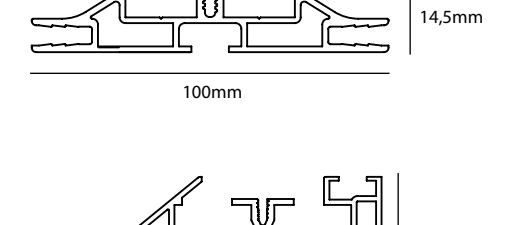
	product code	profile / profiler			
	TEXDSHD44	44x40mm (heavy duty)	6,1mtr		44mm 40mm
	TEXDSL45	45x15mm	3mtr		15mm 45mm

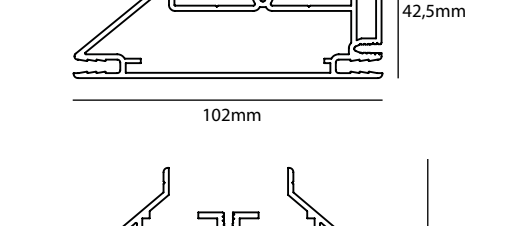
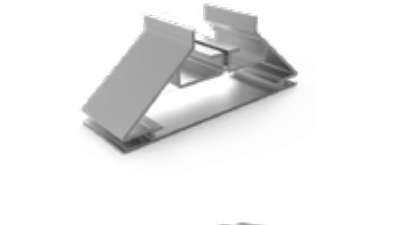
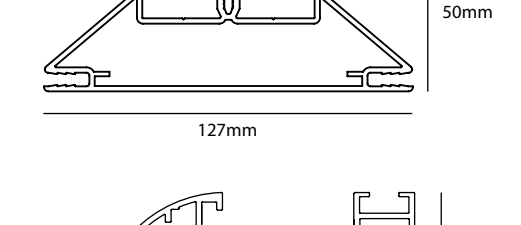
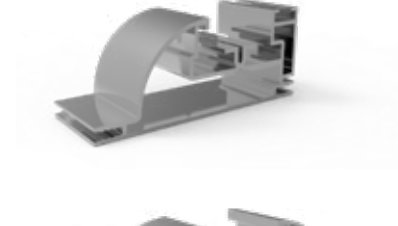
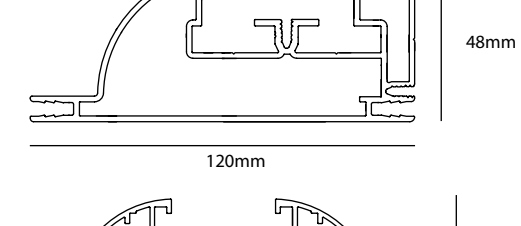
PROFILES / PROFILER

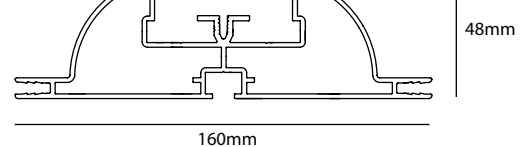
TEXTILE LED FRAME PROFILES / PROFILER FÖR TEXTILRAMAR MED LED

	product code	profile / profil	
	TEXLED50	160x48mm 6,1mtr	 50mm 50mm
	TEXLED80	80x14,5mm 6,1mtr	 14,5mm 80mm
	TEXLED80T	80x14,5mm 6,1mtr	 14,5mm 80mm
	TEXLED100	100x14,5mm 6,1mtr	 14,5mm 100mm
	TEXLED100T	100x14,5mm 6,1mtr	 14,5mm 100mm
	TEXLEDSS-BL	102x42,5mm 6,1mtr	 42,5mm 102mm
	TEXLEDSS-BL	127x50mm 6,1mtr	 50mm 127mm
	TEXLEDSS-EL	120x48mm 6,1mtr	 48mm 120mm
	TEXLEDSS-EL	160x48mm 6,1mtr	 48mm 160mm

PROFILES & ACCESSORIES / PROFILER & ACCESSOARER

CORNER CONNECTORS HÖRNCONNECTORS

product code description



TEXCORN3

for profile / till profil
TEXSSH27, TEXNICHE, TEXDSDL45



TEXCORN1

for profile / till profil
TEXSSLD15, TEXSSLD19, TEXSSHD27,
TEXDSD44, TEXLLS32



TEXCORN2

for profile / till profil
TEXLEDSS(BL/EL), TEXLEDDS(BL/EL)



TEXCORN1

for profile/ till profil
TEXLED80, TEXLED80T
TEXLED100, TEXLED100T
TEXLED50



CONNECTOR1

for profile/ till profil
TEXSSLD15, TEXSSLD19, TEXSSHD27,
TEXLLS32, TEXDSD44, TEXNICHE



CONNECTOR2

for profile/ till profil
TEXSSH27, TEXDSD44,
TEXLED50



CONNECTOR3

for profile/ till profil
TEXLEDSS (BL/EL), TEXLEDDS (BL/EL)



CONNECTOR4

for profile/ till profil
TEXLED80, TEXLED80T
TEXLED100, TEXLED100T

SUSPENSION CLIP CLIP FÖR HÄNGANDE MONTERING

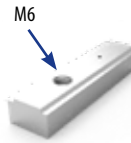

product code description

TEXHANG1

metal suspension clip for 1.5mm cable/
metallclip för hängande montering
TEXDSD44, TEXLEDDS-EL

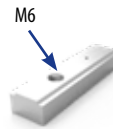

TEXHANG2

metal suspension clip for M6 rod/threaded
bar/ metallclip för hängande montering
TEXLED80T / TEXLED100T

MOUNTING BRACKET MONTERINGSFÄSTEN

product code description



TEXBRACKET1

Wall mounting bracket for
TEXLEDSS(BL/EL) , TEXSSH27



TEXBRACKET2

Wall mounting bracket for
TEXLED80, TEXLED80T
TEXLED100, TEXLED100T

H-SUPPORT PROFILE H-PROFIL

product code profile / profil



TEX-H

36x19mm 3mtr



TEXCLAMP

for profile / till profil
TEX-H



TEXCORNH

connector for profile/
connector till profil
TEXLEDSS (BL/EL) + TEX-H
TEXLEDDS (BL/EL) + TEX-H

PROFILES & ACCESSORIES / PROFILER & ACCESSOARER

MOUNTING CLIP MONTERINGSCLIPS

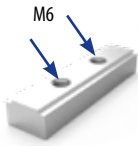

product code description
TEXMOUNT1 metal clip for M6 rod/threaded bar/
 metallclip till
 TEXDSD44 / TEXLEDDS-EL

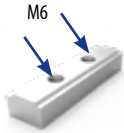

product code description
TEXMOUNT2 metal clip for M6 rod/threaded bar/
 metallclip till TEXLED80T /
 TEXLED100T

STANDING KIT KIT, STÅENDE



product code description
TEXFOOT40 foot / pied 400mm



product code description
TEXFOOT60 foot / fot 600mm



product code description
TEXFEETSIDE side support / sidostöd

FLOOR PLATES GOLVPLATTOR



TEXCIRCLE circle / cirkel \varnothing 450 x 6mm



TEXHOOP hoop / ring \varnothing 450 x 6mm



TEXBASE baseball / baseboll 450 x 300 x 6mm



TEXFILLET fillet / organisk 500 x 180 x 6mm

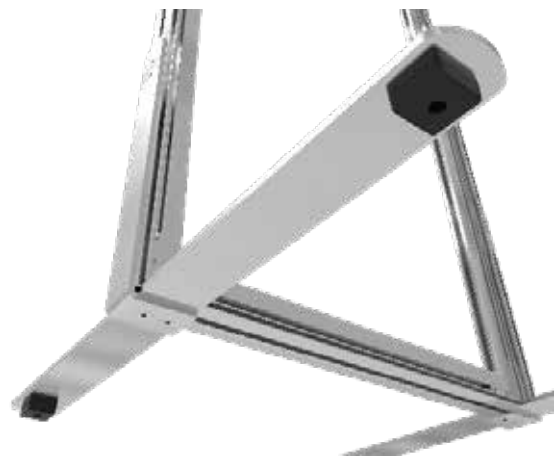

STANDING KIT / STÅENDE KIT	PROFILE / PROFILER	FEET / FÖTTER			CONNECTORS / CONNECTORS	
		TEXFOOT40	TEXFOOT60	TEXFEETSIDE	TEXMOUNT1	TEXMOUNT2
TEXKIT40-1	TEXDSD44 / TEXLEDDS-EL	V			V	
TEXKIT40-1S	TEXDSD44 / TEXLEDDS-EL	V		V	V	
TEXKIT60-1	TEXDSD44 / TEXLEDDS-EL		V		V	
TEXKIT60-1S	TEXDSD44 / TEXLEDDS-EL		V	V	V	
TEXKIT40-2	TEXLED80T / TEXLED100T	V				V
TEXKIT40-2S	TEXLED80T / TEXLED100T	V		V		V
TEXKIT60-2	TEXLED80T / TEXLED100T		V			V
TEXKIT60-2S	TEXLED80T / TEXLED100T		V	V		V

Note:

v = Accessories and screws are included in the kit. / Other textile profiles without track can be used as a freestanding kit while using drill holes.

Notering:

v = Accessoarer och skruvar är inkluderade i kittet / Andra textilprofiler utan spår kan användas som fristående kit om man använder borrhål.

TENSION PROFILES



www.cosign.nu

The Cosign Tension System is one of the most popular solutions for the professional installation of banners, flexface and other printed textiles including mesh and canvas. A very simple and versatile product, it is easy to use and requires no special tools. It is the perfect solution for a wide range of graphics and display projects.:

- Indoor and Outdoor signage projects
- Lightboxes
- Building wraps

Cosign's system vid namn Tension är en av de mest populära lösningarna för professionell installation av banderoller, banners, vepor och andra printade textilier som t.ex. meshväv och canvasduk. Detta är en enkel och mångsidig produkt, som är lätt att använda och som inte kräver några speciella verktyg.

Tension systemet, i dess enkelhet, är en utmärkt lösning till en lång rad av olika display- och utsmyckningsprojekt:

- Lämplig till såväl inom- som utomhusapplikationer
- Går även att använda till ljuslådor
- eller när man vill klä in stora ytor så som hela husfasader.



PROFILES & ACCESSORIES / PROFILER & ACCESSOARER

TENSION PROFILES TENSION PROFILER

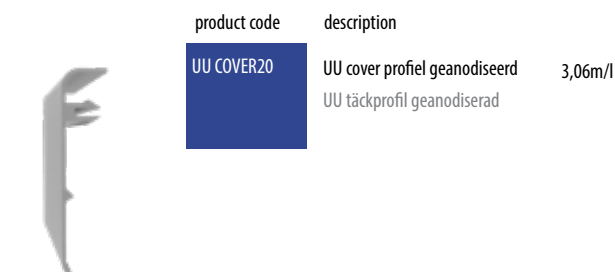
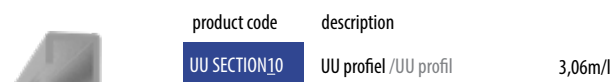
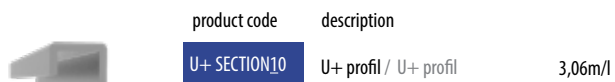
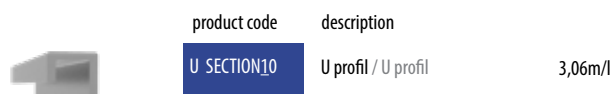

TENSION PROFILES TENSION PROFILER



ACCESSOIRES FOR TENSION PROFILES ACCESSOARER FÖR TENSION PROFILER

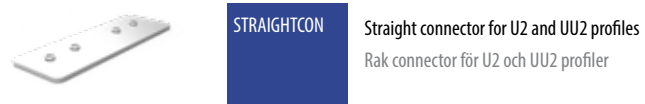
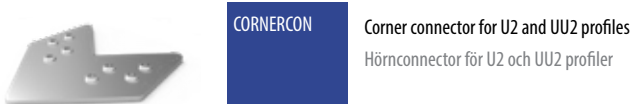

U PROFILE / U PROFIL



U+ PROFILE / U+ PROFIL

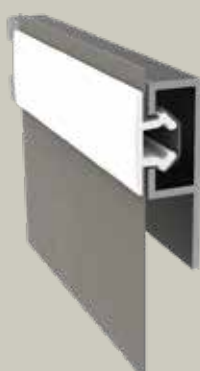

UU PROFILE / UU PROFIL



FIXINGS



www.cosign.nu

TIMELESS ELEGANCE

Over the last 10 years, Cosign has become the leading manufacturer of standoffs & sign fixings in the Benelux. Our designers chose to create fixings in an austere and modern design, in high-quality stainless steel (AISI 303 and 304).

Even though the sign fixings were designed for indoor use, many customers also use them outdoors in non-aggressive environments. Environments with chlorine, salt and metallic fumes must be avoided.

The design takes into account compatibility with sheets of glass. We use silicon rings to protect the sheets of glass or set screws with a nylon tip wherever possible.

Starting in 2015, all our standoffs & sign fixings spacers will also be available in stylish silver anodised aluminium and in a blister pack that will include the wall screws, plugs and allen keys.

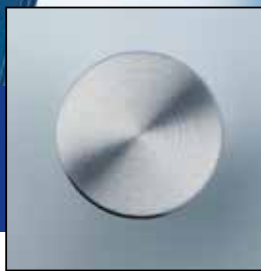

TIDLÖS ELEGANCE

Över de senaste 10 åren har Cosign blivit den ledande tillverkaren av skyltfästen i Belgien. Våra designers har tagit fram fästena och skylttillbehör i en enkel, stilsäker och modern design i rotfrött stål av hög kvalitet (AISI 303 and 304).

Även om fästena i första hand är tänkta att användas inomhus, så har många kunder även kunnat använda dem utomhus, men då i en icke utsatt miljö. Fästena bör inte monteras i miljöer med klor, salt och metalliska ångor.

Samtliga skyltfästen är utformade för att fungera väl med det skivmaterial som utgör skyltbudskapet oacsätt vilken typ av skiva det rör sig om. Silikonringar och skruvar med nylonspets används på de mest utsatta ställena.

Från och med 2015 finns alla skyltfästen tillgängliga även i silveranodiserad aluminium. Ett snyggt och prisvärt alternativ. Alla förpackningar, oavsett material, inkluderar det man behöver till montering, så som skruv och plugg, samt insexnyckel.

DISTANCE HOLDERS / SKYLTFASTEN & DISTANSER

MOUNT BUTTONS / KUPOLMUTTER

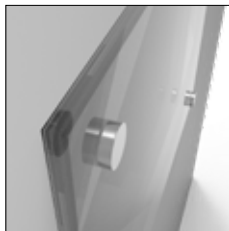

code inox kod inox	code aluminium kod aluminium	diameter (A) diamter
MB130000	MB130000-A	13mm
MB180000	MB180000-A	18mm

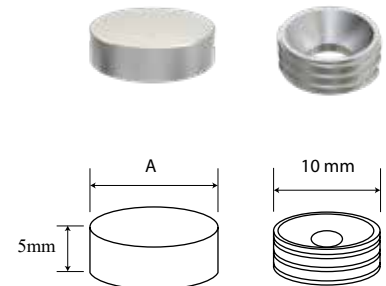
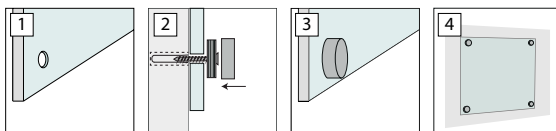

THROUGH HOLE PANEL SUPPORTS / SKYLTFÄSTE FÖR GENOMGÅENDE HÅL



code inox kod inox	code aluminium kod aluminium	diameter (A) diamter	projection (B) distans	panel thickness skivtjocklek	diameter drillhole diamter borrhål
DH131507	DH131507-A	13mm	15mm	2-7mm	8mm
DH132012	DH132012-A	13mm	20mm	2-12mm	8mm
DH181507	DH181507-A	18mm	15mm	2-7mm	12mm
DH182512	DH182512-A	18mm	25mm	2-12mm	12mm
DH302512	DH302512-A	30mm	25mm	2-12mm	15mm

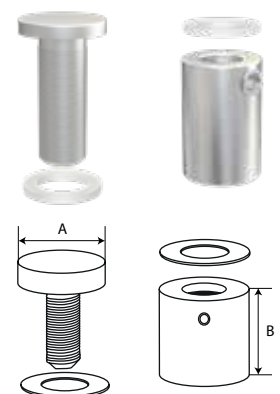
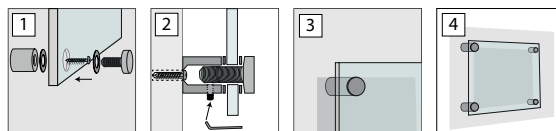

SIDE GRIP PANEL SUPPORTS / SKYLTFÄSTE SOM GREPPAR FRÅN SIDAN



code inox kod inox	code aluminium kod aluminium	diameter (A) diamter	projection (B) distans	panel thickness skivtjocklek
SG182008	SG182008-A	18mm	20mm	max 8mm
SG302008	SG302008-A	30mm	20mm	max 8mm

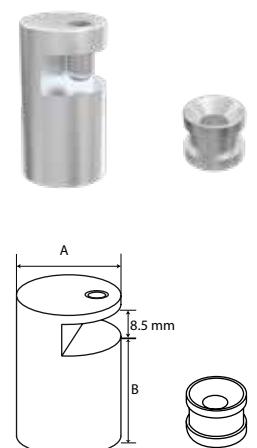
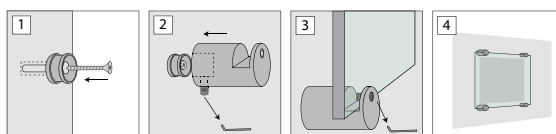

DISTANCE HOLDERS / SKYLTFÄSTEN & DISTANSER

WALL-CEILING PANEL GRIPS / SKYLTFÄSTE FÖR UTSTICKANDE SKYLTT (VÄGG ELLER TAK)



code inox kod inox	code aluminium kod aluminium	diameter diameter	panel thickness skivtjocklek
WG170008	WG170008-A	17mm	max 8mm

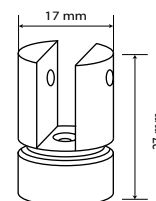
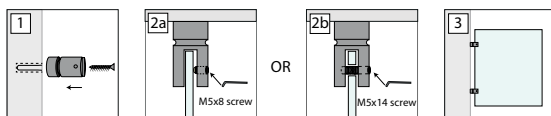

SUSPENSION KIT / SKYLTFÄSTEN FÖR HÄNGANDE SKYLTT

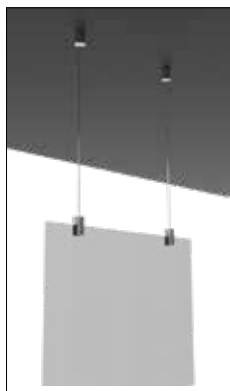

code inox kod inox	code aluminium kod aluminium	diameter diameter	panel thickness skivtjocklek	description beskrivning
CC15HP06	CC15HP06-A	17mm	max 6mm	suspension clamp enbart skyltfäste
CC15KIT4	CC15KIT4-A	17mm	max 6mm	suspension kit incl. ceilingconnector and wire. kit som inkluderar 1st skyltfäste, 1st enklare takfäste och 1st vajer.

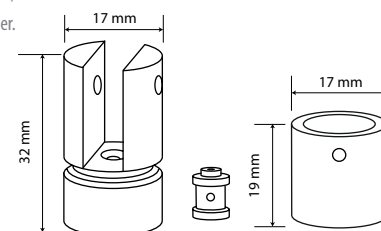
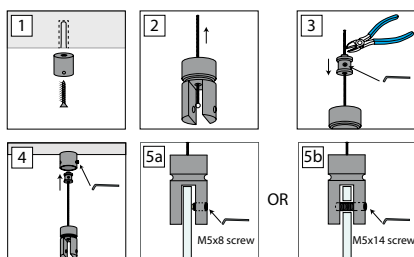

SUSPENSION KITS



www.cosign.nu

EASE OF USE

Cosign developed a range of suspension systems which guarantee an easy, cost effective and safe suspension of signage, lighting systems, cable trays and other applications.

All systems have a built-in locking mechanism that grips cables automatically. To release, just press the clutch button, and the cable is free to move back and forth to achieve the desired length.

Our suspension range offers a solution for all types of ceilings: conventional ceilings, suspended ceilings, ceilings with metal tiles or high open ceilings with visible structural supports.



ENKELA ATT ANVÄNDA

Cosign har utvecklat en rad av vadersystem för hängande skyltar som garanterar en lätthanterlig, prisvärd och säker installation.

Alla varianterna av vajerfästen har en inbyggd låsmekanism som automatiskt greppar tag i vadjern. För att få vadjern att släppa, så finns det en knapp man trycker på. När vadjern är i friläge kan man justera så man får den höjd man vill ha.

I sortimentet finns vadersystem och skyltlösningar för alla typer av tak; allt från vanliga innertak med plattor, paneler och skenor, till tak med metallplattor eller betong, nedsänkta tak eller tak med mer öppen struktur och synliga bjälkar

SUSPENSION SYSTEMS / HÄNGANDE SKYLtar

SUSPENSION CLIPS / TAKFÄSTEN

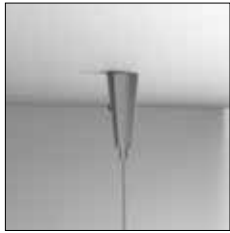

code kod

APC-4001

description
beskrivning

Suspension Clip Conical
Koniskt takfäste

cable thickness
vajertjocklek

max 1.5mm

max weight
max vikt

20,0kg

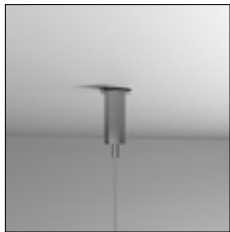

code

APC-4002

description
beskrivning

Suspension Clip Cylindrical
Cylindriskt takfäste

cable thickness
vajertjocklek

max 1.5mm

max weight
max vikt

20,0kg



code

APC-4003

description
beskrivning

Suspension Clip Eco
Ecotakfäste

cable thickness
vajertjocklek

max 1.5mm

max weight
max vikt

20,0kg



CABLE / VAJER

code

APC-CABLE-1.5

description
beskrivning

Galvanized cable (7x7). 1,5m length
with 4,5mm ball nipple.

Galvaniserad vajer (7x7). 1,5m lång med 4,5mm kulnippel

cable thickness
vajertjocklek

1.5mm

max weight
max vikt

16kg



NOTE:

Always consider maximum load of any used part of the total suspension system.

Håll koll på vilken maxvikt de individuella delarna i den upphängningsanordning du använder klarar.

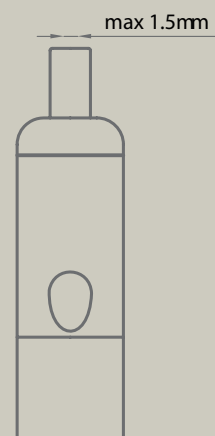
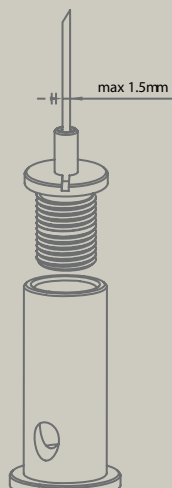
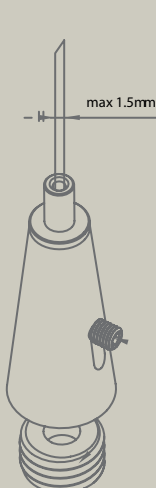

SUSPENSION SYSTEMS / HÄNGANDE SKYLTA

MAGNETIC ANCHOR / MAGNET FÄSTE



code	description beskrivning	cable thickness vajertjocklek	max weight max vikt
APC-MG32	Magnetic Anchor 32mm incl gripper Magnetfäste, 32mm inkl. vajerlåsning	max 1.5mm	2kg



DOUBLE GRIPPER / VAJERFÄSTE

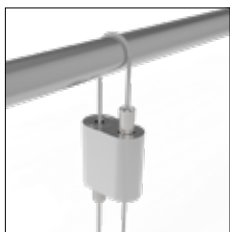

code	description beskrivning	cable thickness kabeltjocklek	max weight max vikt
APC-DG15-B	Double Gripper 1.5mm Black svart	max 1.5mm	20kg
APC-DG15-S	Double Gripper 1.5mm Silver silver	max 1.5mm	20kg
APC-DG30-B	Double Gripper 3.0mm Black svart	max 3,0mm	90kg
APC-DG30-S	Double Gripper 3.0mm Silver silver	max 3,0mm	90kg

Vajerfäste med dubbel genomföring/vajerlås



TWISTER CLIPS / FÄSTE FÖR TAKSKENA



code	description beskrivning	cable thickness kabeltjocklek
APC-TW00	Twister Clip with 5,6mm loop med ögglå	-
APC-TW03	Twister Clip with Gripper med vajerlås	max 1.5mm

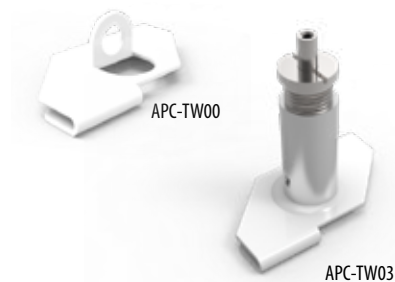

magnet strength: N35

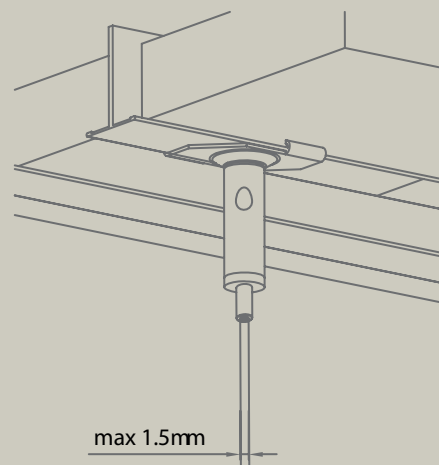
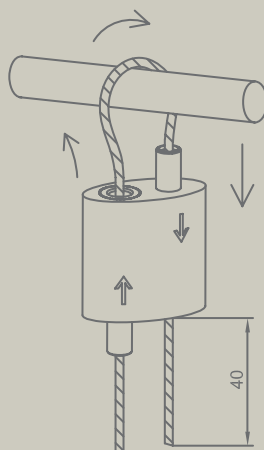

MODULE PLUS OUTDOOR



www.cosign.be/moduleplusoutdoor

STYLISH MODULAR OUTDOOR SIGNS

With Module Plus Outdoor, Cosign has developed a modular system for outdoor signs that is often prescribed by architects and designers worldwide and that sign makers like to use because of its versatility and convenience and the option of making unique custom-made signs.

Module Plus Outdoor offers the perfect solution everywhere where a building or location needs to be indicated, a message must be presented or people must be shown the correct place regardless of whether this is for an industrial estate, a company or office building, a hospital, a school, a shopping center or a car park. Appropriate outdoor signs will also contribute towards strengthening a company's corporate identity.

The Module Plus Outdoor system consists of a series of round, square, triangular, octagonal and ellipse-shaped aluminium poles and text panels (box profiles) with a height of 46 mm, 60 mm, 100 mm, 120 mm, 150 mm, 200 mm and 250 mm. The text panels can be fixed by using special panel clamps. Other innovative accessories ensure that panels can be integrated which are made of different materials in any required size.

Recent innovations with regards to the poles, top caps and panel clamps will give the Module Plus Outdoor a very modern look. Cosign has added a 60mm and 80mm square pole and a 60mm and 90mm triangular one. The new injection molded aluminium top caps will be available in grey and black. The existing panel clamps have been modified to increase installation efficiency. All new items are compatible with the existing system and provide new innovative possibilities.



SIGNALISATION EXTÉRIÈRE MODULAIRE PARTICULIÈREMENT RAFFINÉE

Avec le Module Plus Outdoor, Cosign a lancé un système modulaire de signalisation extérieure fréquemment prescrit par les architectes et designers du monde entier et souvent utilisé par les fabricants d'enseignes du fait de sa grande polyvalence, de sa facilité d'utilisation, et de la possibilité de réaliser des enseignes uniques entièrement sur mesure.

Le Module Plus Outdoor constitue la solution idéale chaque fois qu'il est nécessaire d'indiquer un bâtiment ou un lieu, d'afficher un message ou d'orienter les visiteurs vers un endroit particulier, que ce soit dans un zoning industriel, un bâtiment d'entreprise, un immeuble de bureaux, un hôpital, une école, un center commercial ou un parking. Une signalisation extérieure de qualité contribue également au renforcement de l'image de marque de l'entreprise.

Le système Module Plus Outdoor se compose d'une série de poteaux en aluminium de section ronde, carrée ou elliptique, ainsi que de panneaux à texte en aluminium (profilés du type caisson) d'une hauteur de 46, 60, 100, 120, 150, 200 ou 250 mm. Les panneaux à texte sont fixés à l'aide d'attaches spéciales. D'autres accessoires innovants permettent d'intégrer des panneaux de toute taille, fabriqués en différents types de matériaux.

Des innovations récentes en ce qui concerne les poteaux, les capuchons et les crampons donneront le Module Plus Outdoor un look très moderne. Cosign a ajouté un poteau carré de 60 mm et de 80 mm et un poteau triangulaire de 60 mm et de 90 mm. Les nouveaux capuchons seront produits par moulage sous pression en aluminium gris et noir. Les crampons existants ont été modifiés afin d'augmenter l'efficacité de l'installation. Tous les nouveaux éléments peuvent être utilisés avec le système actuel et offrent de nouvelles possibilités innovantes.



PROFILES / PROFILÉS

ALUMINIUM POLES / POTEAUX ALUMINIUM

ROUND POLES / POTEAUX ROUNDS

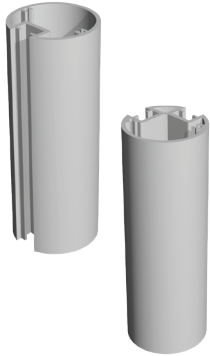

product code	description	
A00 1 60R1T	60mm round, 1-slot	6m/l
A00 1 60R2T	60mm round, 2-slots 60°	5m/l

1. mill finish brut 2. silver anodised anodisé naturel

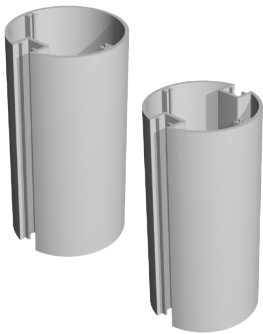

product code	description	
A00 1 90R1T	90mm round, 1-slot	6m/l
A00 1 90R2T	90mm round, 2 slots 180°	5m/l

1. mill finish brut 2. silver anodised anodisé naturel

NEW SQUARE POLES / POTEAUX CARRÉS

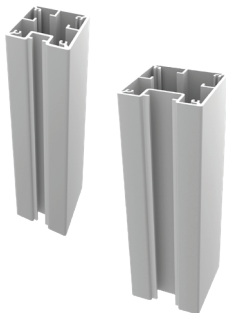

product code	description	
A00 1 60S1T	60mm square, 1-slot	6m/l
A00 1 80S1T	80mm square, 1-slot	6m/l

1. mill finish brut 2. silver anodised anodisé naturel

TOPCAPS OF POLES / CAPUCHONS

ROUND TOPCAPS / CAPUCHONS ROUNDS



product code	description	
AOTR601 1	60mm round, laser cut 2mm	60mm rond, coupé par laser 2mm

1. mill finish brut 2. silver anodised anodisé naturel



product code	description	
AOT600 1	60mm round, pp	60mm rond, pp

1. white/ blanc 2. grey/ gris 3. black/ noir



NEW

product code	description	
AOTR600 2	60mm round, die cast	60mm rond, moulé sous pression

2. grey powder coated laqué en gris 3. black powder coated laqué en noir



product code	description	
AOTR901 1	90mm round, laser cut 2mm	90mm rond, coupé par laser 2mm

1. mill finish brut 2. silver anodised anodisé naturel



NEW

product code	description	
AOTR900 2	90mm round, die cast	90mm rond, moulé sous pression

2. grey powder coated laqué en gris 3. black powder coated laqué en noir

SQUARE TOPCAPS / CAPUCHONS CARRÉS



NEW

product code	description	
AOTS601 1	60mm square, laser cut 2mm	60mm carré, coupé par laser 2mm

1. mill finish brut 2. silver anodised anodisé naturel

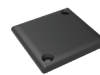

NEW

product code	description	
AOTS600 2	60mm square, die cast	60mm carré, moulé sous pression

2. grey powder coated laqué en gris 3. black powder coated laqué en noir



NEW

product code	description	
AOTS801 1	80mm square, laser cut 2mm	80mm carré, coupé par laser 2mm

1. mill finish brut 2. silver anodised anodisé naturel



NEW

product code	description	
AOTS800 2	80mm square, die cast	80mm carré, moulé sous pression

2. grey powder coated laqué en gris 3. black powder coated laqué en noir

ALUMINIUM POLES / POTEAUX ALUMINIUM

NEW TRIANGULAR POLES POTEAUX TRIANGULAIRES



product code	description	
A00 1 60T1T	60mm triangular, 1-slot	6m/l
A00 1 90T1T	90mm triangular, 1-slot	6m/l
	1. mill finish brut	2. silver anodised anodisé naturel

OCTAGONAL POLES POTEAUX OCTOGONAUX

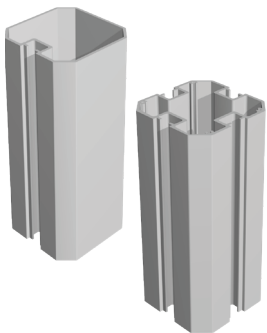

product code	description	
A00 1 8081T	80mm octagonal, 1-slot	5m/l
A00 1 8084T	80mm octagonal, 4-slots	5m/l
	1. mill finish brut	2. silver anodised anodisé naturel

ELLIPTICAL POLES POTEAUX ELLIPTIQUES

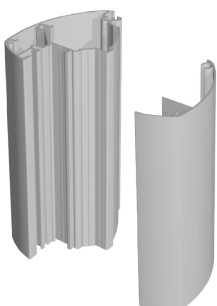

product code	description	
ELP 1 000	elliptical base profile	5m/l
ELP 1 001	elliptical hinge profile	5m/l
	1. mill finish brut	2. silver anodised anodisé naturel

TOPCAPS OF POLES / CAPUCHONS

TRIANGULAR TOPCAPS CAPUCHONS TRIANGULAIRES

product code	description	
NEW AOTT601 1	60mm triangular, laser cut 2mm 60mm triangulaire, coupé par laser 2mm	1. mill finish brut
		2. silver anodised anodisé naturel
NEW AOTT600 2	60mm triangular, die cast 60mm triangulaire, moulé sous pression	2. grey powder coated laqué en gris
		3. black powder coated laqué en noir
NEW AOTT901 1	90mm triangular, laser cut 2mm 90mm triangulaire, coupé par laser 2mm	1. mill finish brut
		2. silver anodised anodisé naturel
NEW AOTT900 2	90mm triangular, die cast 90mm triangulaire, moulé sous pression	2. grey powder coated laqué en gris
		3. black powder coated laqué en noir

OCTAGONAL TOPCAPS CAPUCHONS OCTOGONAUX

product code	description	
AOT8081	80mm octagonal, pp 80mm octogonaux, pp	1. white/ blanc 2. grey/ gris 3. black/ noir
AOT8084	80mm octagonal, 4 slots, pe 80mm octogonaux, 4 slots, pe	black acrylic / acrylic noir

ELLIPTICAL TOPCAPS CAPUCHONS ELLIPTIQUES

product code	description	
AOTE101 1	elliptical topcap, laser cut 2mm capuchon elliptique, coupé par laser 2mm	1. mill finish brut
		2. silver anodised anodisé naturel

ACCESSORIES / ACCESSOIRES

DOUBLE SIDED TEXTPANELS / CAISSONS DOUBLE FACE

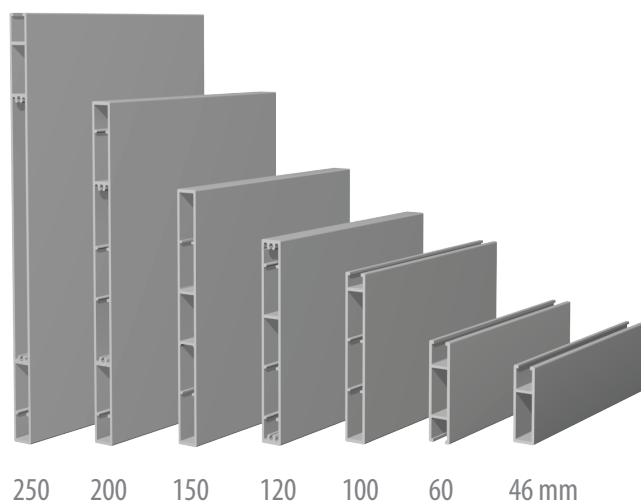

product code	description	
A00_1_250	250mm	5m/l
A00_1_200	200mm	5m/l
A00_1_150	150mm	5m/l
A00_1_120	120mm	5m/l
A00_1_100	100mm	5m/l
A00_1_060	60mm	5m/l
A00_1_046	46mm	5m/l

1. mill finish brut
2. silver anodised anodisé naturel

* Note : text panel open on top side : 250, 100, 46 mm
text panel open on both sides : 60 mm

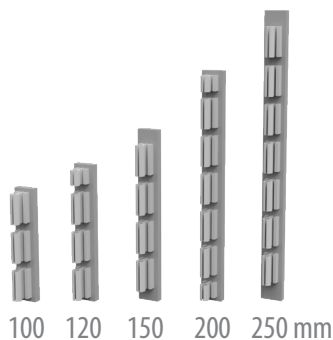

ALUMINIUM ENDCAPS PROFILÉS ALUMINIUM OBTURATEUR POUR CAISSONS



product code	description
AOC_1_250	250mm
AOC_1_200	200mm
AOC_1_150	150mm
AOC_1_120	120mm
AOC_1_100	100mm

1. mill finish brut
2. silver anodised anodisé naturel

PANEL CLAMP CRAMPON DE FIXATION

	product code	description
	AACL002	with inox screw / avec vis inox
	TOOL001	drilling guide for AACL002 / gabarit de perçage pour AACL002
	FIXBOX001	without screw / sans vis



ACCESSORIES / ACCESSOIRES

STEEL FEET / PIEDS EN ACIER

product code	description
FEE1600	60mm round pole / poteau rond
DECOFEE2600	decorative foot / pied décoratif 60mm round pole / poteau rond
FEE19001T	90mm round pole / poteau rond
FEE19002T	90mm round pole / poteau rond, 2-slots
FEE18081T	80mm pole / poteau octogonal
FEE18084T	80mm pole / poteau octogonal, 4-slots
NEW FEE1605T	60mm square & triangular pole 60mm carré de triangulaire poteau
FEE1805T	80mm square & 90mm triangular pole 80mm carré de 90mm triangulaire poteau

FINISHING PROFILES / PROFILÉS DE FINITION

product code	description	
AOCO_1_00	finishing profile / profilé de finition 1. mill finish brut 2. silver anodised anodisé naturel	5m/l
ADAPTER_1_0	adapter profile / profilé de connection 1. mill finish brut 2. silver anodised anodisé naturel	5m/l
AORO_1_00	reduction profile / profilé de reduction 4mm plate material to be used instead of 8mm 1. mill finish brut 2. silver anodised anodisé naturel	5m/l
AOC_1_000	finishing profile of elliptical pole / profilé de finition 1. mill finish brut 2. silver anodised anodisé naturel	5m/l

ROUND CORNER CONNECTOR / ANGLE ARRONDI

product code	description
CORN_1_090	mill finish, for round pole 90mm brut, pour poteau rond 90mm

SCREW CAP / BOUCHON À VIS

product code	description
NOP002	screw cap / bouchon à vis 1. white/ blanc 2. grey/ gris



INSTALLATION GUIDE / GUIDE D'INSTALLATION

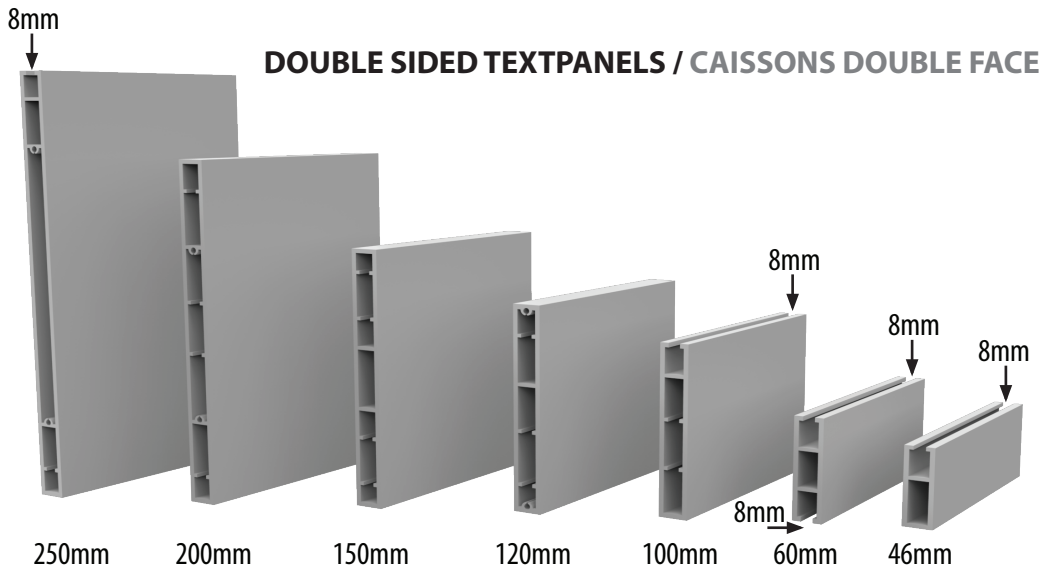

PANEL CLAMP / CRAMPON DE FIXATION

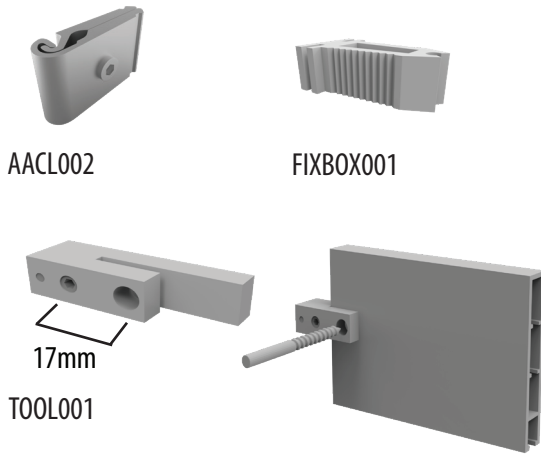

ALUMINIUM ENDCAPS PROFILÉS ALUMINIUM OBTURATEUR POUR CAISSONS

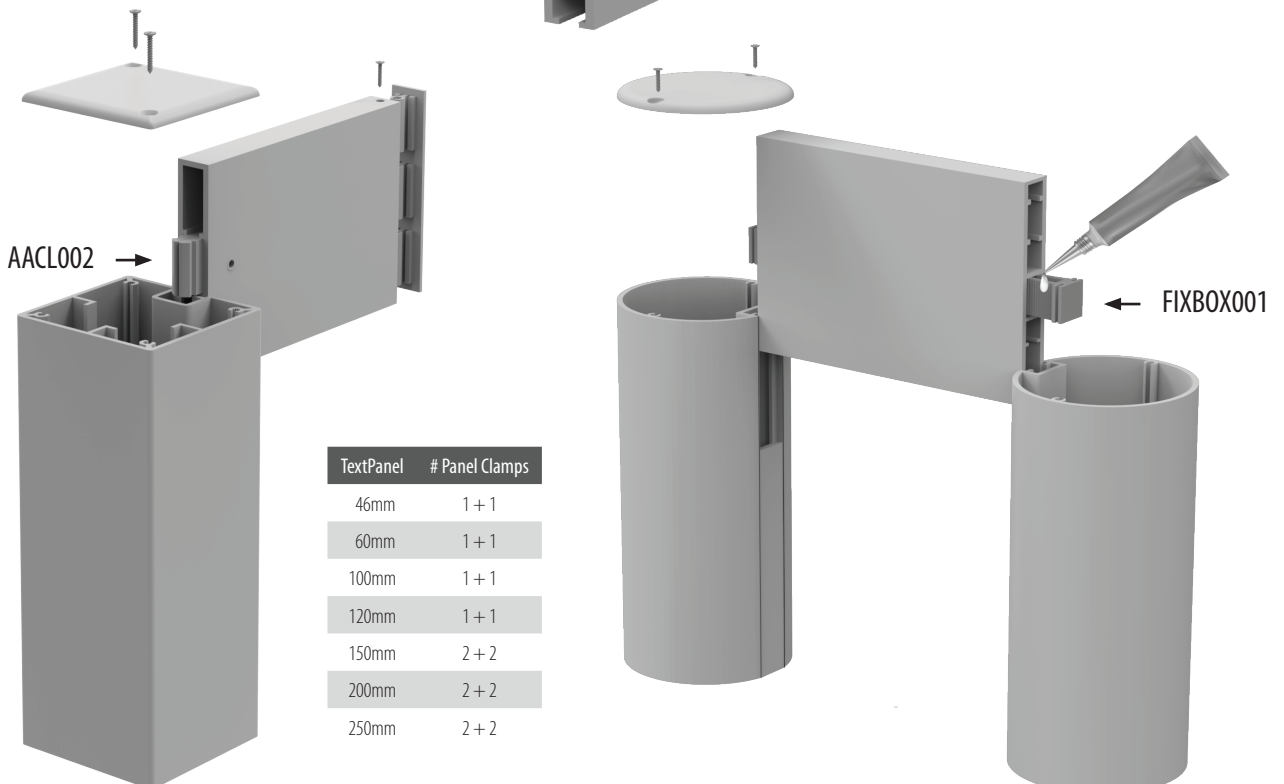
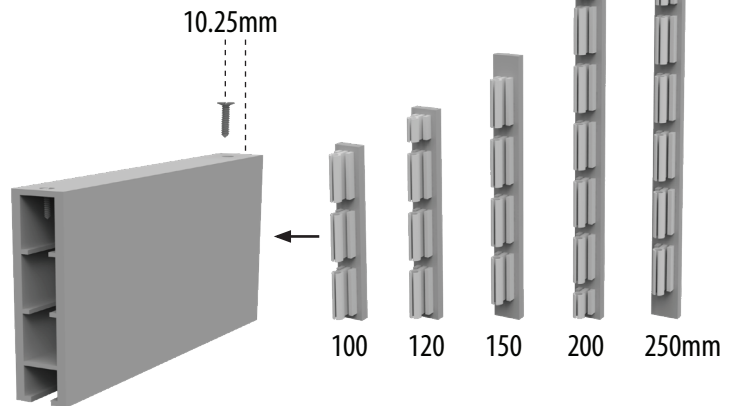

INSTALLATION GUIDE / GUIDE D'INSTALLATION

FINISHING PROFILE / PROFILÉS DE FINITION

REDUCTION PROFILE / PROFILÉ DE REDUCTION

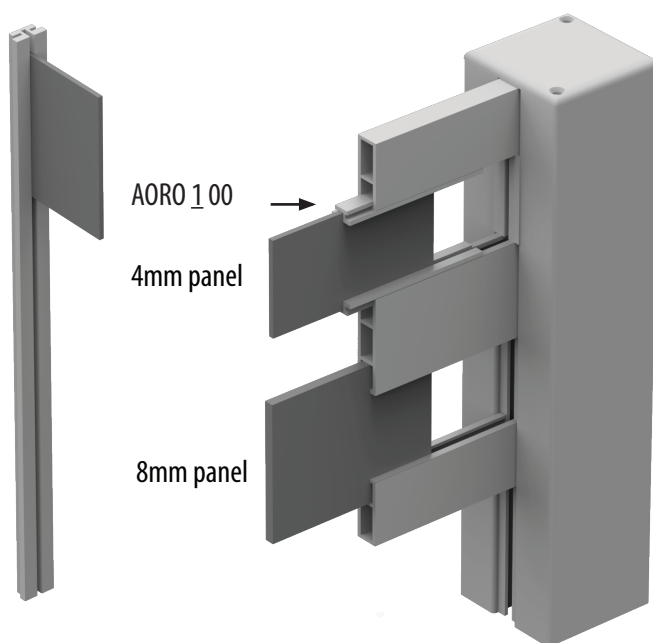

ADAPTER PROFILE PROFILÉ DE CONNEXION

OCTAGONAL POLE WITH TEXT PANELS POTEAU OCTOGONAL AVEC CAISSONS DOUBLE FACE

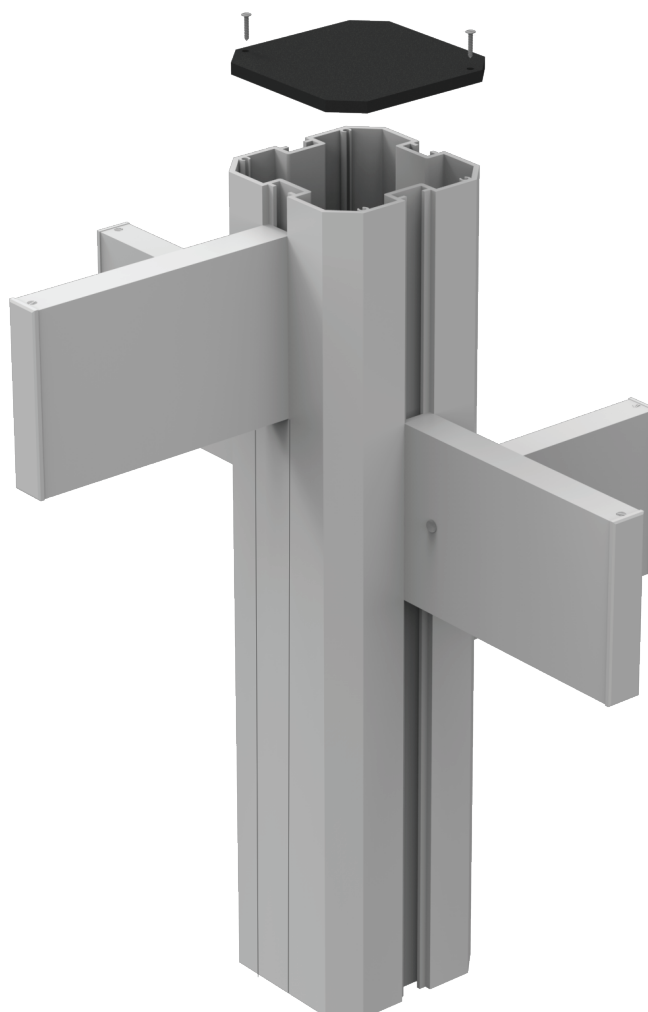
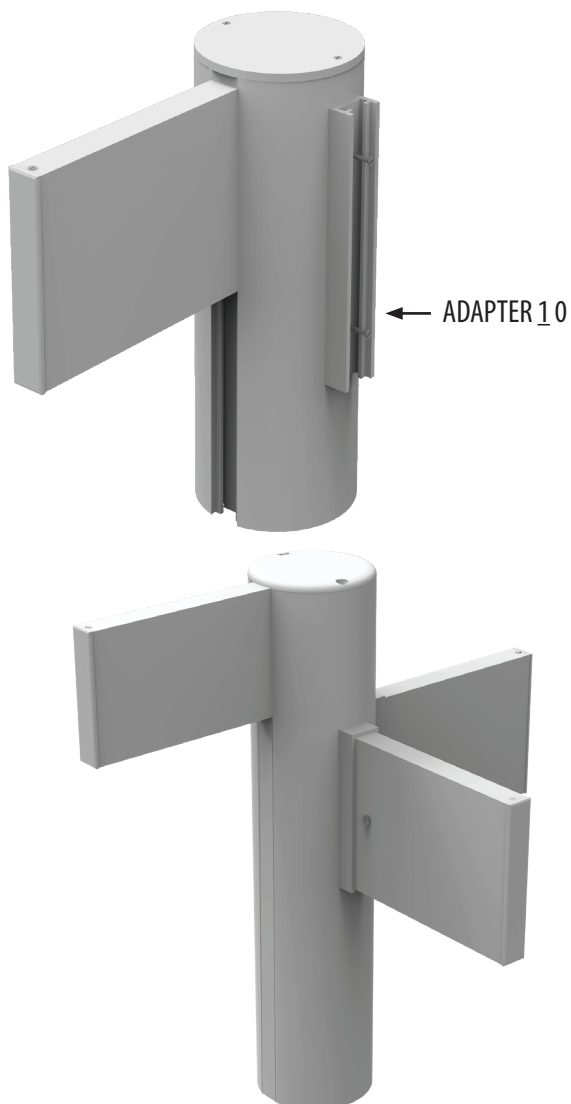

INSTALLATION GUIDE / GUIDE D'INSTALLATION

ELLIPTICAL POLE ASSEMBLY ASSEMBLAGE DE POTEAUX ELLIPTIQUES

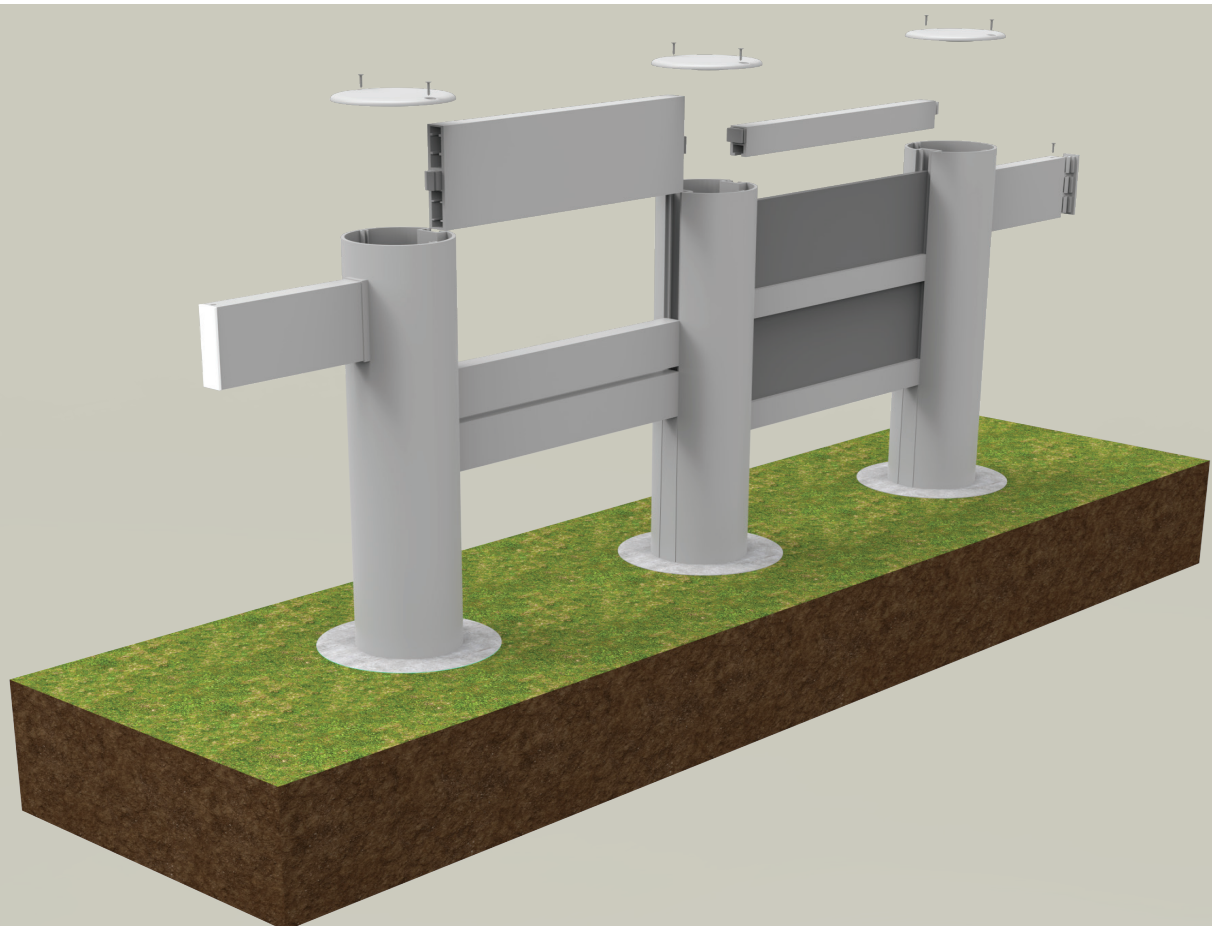

INSTALLATION GUIDE / GUIDE D'INSTALLATION

RULES OF THUMB FOR SIGNS WITH MAXIMUM HEIGHT OF 2500MM OR MAXIMUM PANEL SURFACE OF 2M²

Concrete foundation:

1. Minimum diameter = 300mm
2. Depth (D) = 40% of the height of the structure (H) with a minimum of 300mm
3. The concrete should have at least 350 kg of cement per cubic meter

INSTALLING OPTIONS

1. POLES IN FOUNDATION

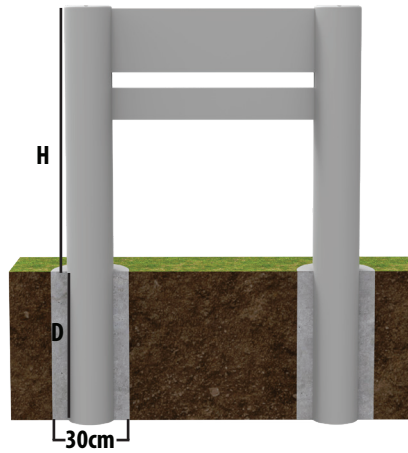

Example 1:
(H = 2m)

D = 40% x 2000mm
D = 800mm

Example 2:
(H = 50cm)

D = 40% x 500mm
D = 300mm
(MINIMUM REQUIREMENT)

2. INTERNAL STEEL STRUCTURE

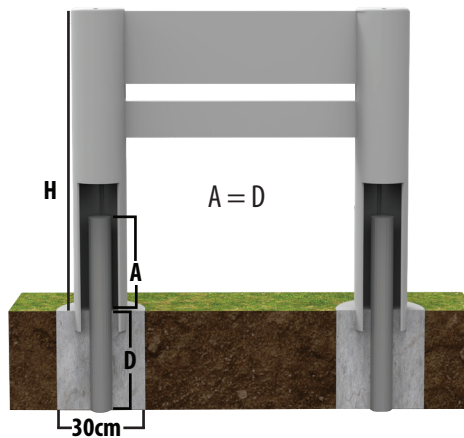

3. STEEL FEET / CHEMICAL ANCHORING

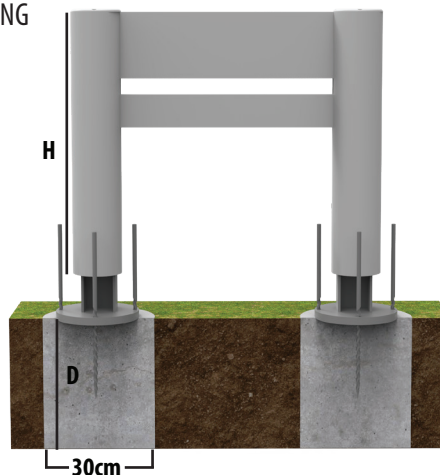

DISCLAIMER

The recommendations stated above are purely indicative. Since Cosign has no information regarding the specific location of the Module Plus Outdoor installation, the conditions of the soil and the composition of the concrete foundation, Cosign shall not be liable for any direct, indirect, incidental or consequential damages, arising out of or in any way connected with the use or misuse of our general advice.

For Module Plus Outdoor structures > 2,5m or a panel surface > 2m², please contact an engineering firm for strength/ stability calculations.

ADVERTISING PILLARS
INFORMATION PILLARS
ORIENTATION PILLARS
SIGNPOSTING

ANNONSPELARE
INFORAMTIONSKYLTA
ÖVERSIKTSSKYLTA
HÄNVISNINGSSKYLTA



TOTEM PYLON

TOP-CLASS

Advertising pillars are omnipresent on today's street scene. A carefully designed advertising pillar makes you easier to find and contributes to the brand awareness and corporate identity of a company.

Cosign is an important manufacturer of profiles and accessories required for building advertising pillars or totems in the Benelux. We only deliver to the sign industry. In addition to the 'classical' range of totem profiles, Cosign developed a modular system with Modular Totem that sign makers can use to construct totems in a chosen shape.

Depending on the chosen profile and internal structure, the sign maker can make small, elegant indoor totems as well as large, sturdy totems of up to 6 metres high.

Cosign will offer profiles and accessories as well as a series of ready-made totems, flat or oval, of exceptional quality to professional sign makers starting in 2015.

TOTEM

TOPPKLASS

Annonspelare finns överallt i dagens samhälle. En väl designad annonspelare synliggör din företagsverksamhet samtidigt som den bidrar till att stärka varumärket och den visuella identiteten.

När det gäller tillverkning av de aluminiumprofiler och de tillbehör som behövs för att bygga ihop denna typ av annonspelare, så är Cosign är en stor aktör, speciellt i Belgien, där företaget först grundades.

Genom att välja en lämplig totemprofil som passar för ändamålet så kan man skapa såväl små, eleganta, golvstående inomhusskyltar, som stora, stabila utomhusskyltpelare upp till 6 meter höga. Till de större skyltarna är det oftast nödvändigt med en inre ram i aluminium eller stål.

Cosign levererar uteslutande till skyltmakare. Förutom profiler och tillbehör erbjuder de även en serie med "ready-made" annonspelare, antingen plana eller elliptiska i formen, i utmärkt kvalité.

TOTEM PYLON



www.cosign.nu

Everyone is familiar with Cosign's 'classic' totem profiles, which are used to make illuminated or non-illuminated elegant, curved or elliptical advertising pillars.

Depending on the application, location and desired size, the sign maker can choose our totem pylon 50 mm or totem pylon 80 mm for smaller totems (up to 3 metres) or our totem pylon 137 mm and the more recent H-profile for larger totems (up to 6 metres).

De allra flesta är har någon gång stött på Cosign's klassiska Totem skyltprofiler. Dessa profiler utgör grunden i många av dagens reklampelare och kännetecknas av sin eleganta, svagt utbuktande, eller helt elliptiska form. Naturligtvis finns de i både belyst och icke belyst utförande.

Välj mellan ELLIPSE 50mm och ELLIPSE 80mm för mindre reklampelare (upp till 3m hög) eller ELLIPSE 137mm och nytilskottet H-profilen för större pyloner (upp till 6m hög).



ALUMINIUM PROFILES

ALUMINIUM PROFILER

ELLIPSE 50mm ELLIPSE 50mm



product code profile / profil
TOT 1 050 50mm 6m/l

1. mill finish 2. silver anodised 3. color
 mill silver anodiserad färg



Double sided sign support 46mm (A001046)
 xDubbelsidigt stöd, 46mm(A001046)

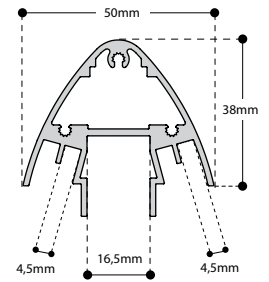

ELLIPSE 80mm ELLIPSE 80mm

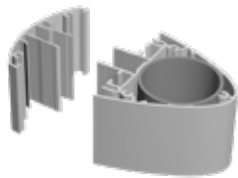

product code profile
TOT 1 080 80mm 6m/l

1. mill finish 2. silver anodised 3. color
 mill silveranodiserad färg

TOTCLOSE1080 avslutning / avslutning 6m/l

1. mill finish 2. silver anodised 3. color
 mill silveranodiserad färg



Round tube 50 x 4mm
 Rund tube 50 x 4mm

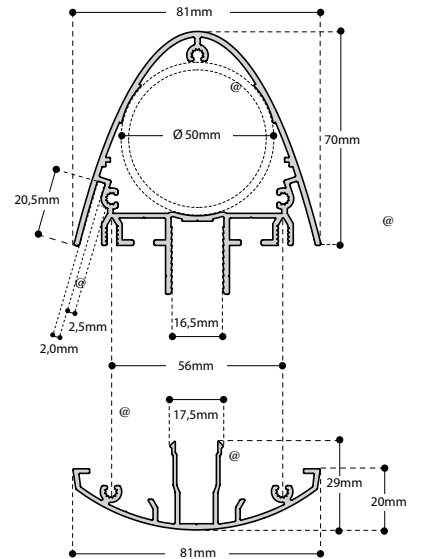

ELLIPSE 137mm ELLIPSE 137mm

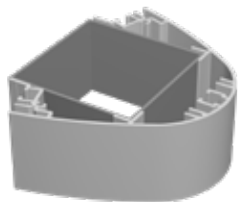

product code profile / profilé
TOT 1 137 137mm 6m/l

1. mill finish 2. silver anodised 3. color
 mill silveranodiserad färg



Aluminium or steel profile 80 x 80 x 4mm
 Aluminium- eller stålprofil 80 x 80 x 4mm

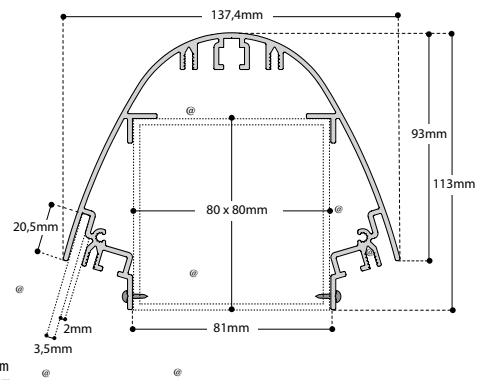

H-PROFILE PROFILE-H

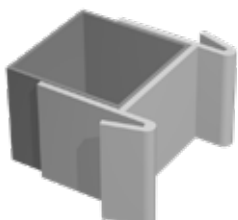

product code profile / profilé
TOTH 1 060 H, 60mm 6m/l

1. mill finish 2. silver anodised 3. color
 mill silveranodiserad färg



Aluminium or steel profile 60 x 60 x 4mm
 Aluminium- eller stålprofil 60 x 60 x 4mm

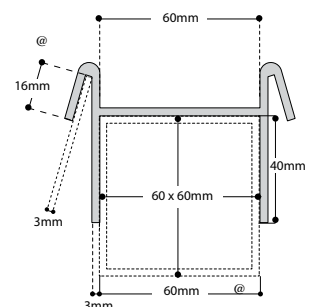

COSIGN

ARCHITECTURAL SIGNAGE



ARCHITECTURAL SIGNAGE | TEXTILE FRAMES | POS PRODUCTS | LED SOLUTIONS

Cosign is a designer, manufacturer and distributor of architectural signage & way finding solutions, poster frames & displays, led modules and sign making tools. Based in Belgium with regional offices in Mexico, Brazil and India, and through our global partner network, our sign solutions are available in more than 80 countries.

Cosign är en utvecklare, tillverkare och distributör av arkitektonisk skyltning, vägvisande skyltlösningar, textilramar, klicksystem med snäppramar och displaylösningar, LED-moduler och skyltmakartillbehör m.m. Huvudkontoret är baserat i Belgien med regionala kontor i Mexico, Brasilien och Indien. Tack vare vårt globala nätverk av återförsäljare är våra skyltlösningar och produkter tillgängliga i mer än 80 länder.

COSIGN

YOUR DEALER / VOTRE REVENDEUR:

