

I-SIGN ECO

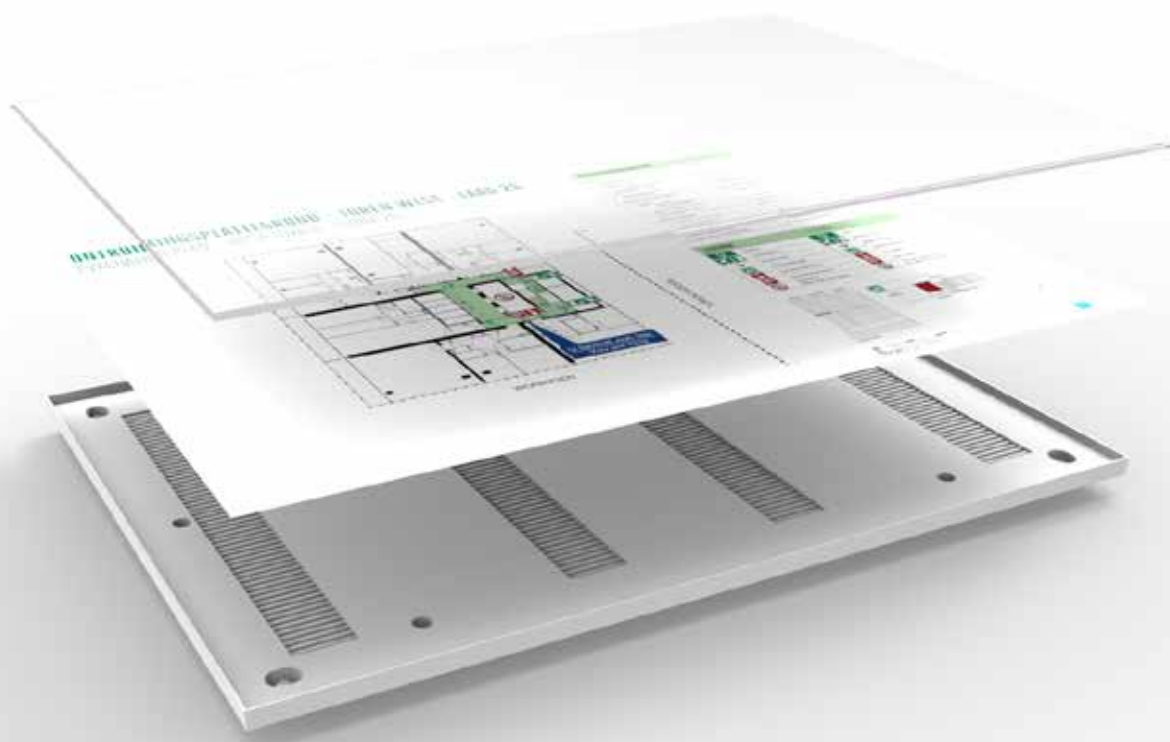

www.cosign.be/i-sign-eco

I-Sign Eco is the newest member of the I-Sign family. I-Sign Eco maintains the same sleek design with the thin edge which became so typical for the entire I-Sign range.

It is possible to create single-sided wall mounting or double-sided suspended or flag mounting signs.

I-Sign Eco est le produit le plus récent de notre gamme I-Sign. I-Sign Eco conserve le même design moderne avec une fine bordure, typiquement pour toute la gamme I-Sign.

Il est possible de créer des enseignes de montage mural (simple face), suspendues au plafond (double face) ou fixation en drapeau (double face).



CUSTOM
MADE

READY
MADE

One Frame, Two Functions

Un Cadre, Deux Fonctions

The user can choose between a flexible version with a paper inlay behind a non-reflecting acrylic cover, or a more fixed version with 2 or 3mm thick sheets in different materials like PVC, ACM, acrylic or aluminium which allow for a highly customized solution.

L'utilisateur peut choisir entre une version flexible avec une feuille de papier derrière une face acrylique non réfléchissante, et une version plus fixe avec des plaques de 2 ou 3 mm d'épaisseur dans différents matériaux comme le PVC, l'ACM, l'acrylique ou l'aluminium, ce qui permet une solution hautement personnalisée.

I-SIGN ECO FIX

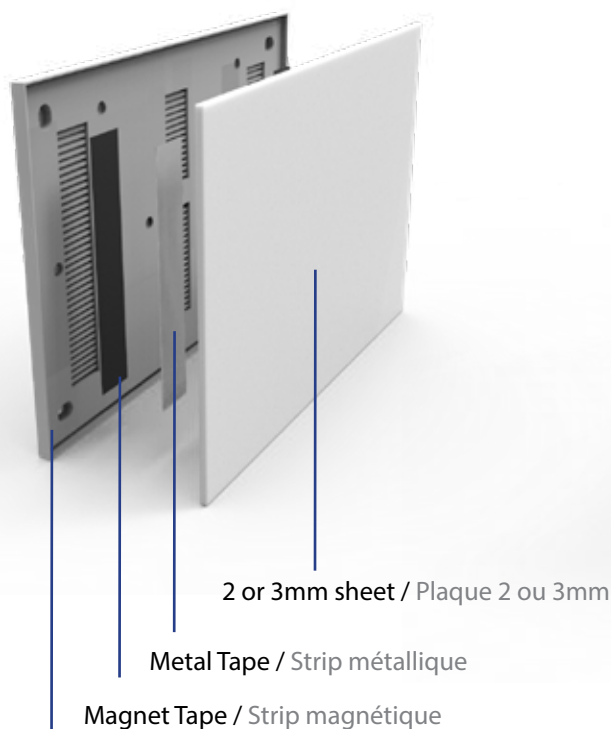

I-Sign Eco frame / Cadre I-Sign Eco

I-SIGN ECO FLEX

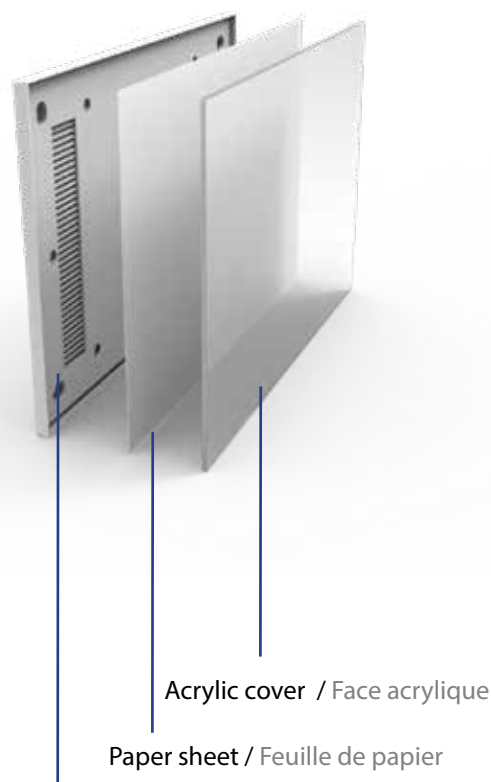

I-Sign Eco frame / Cadre I-Sign Eco

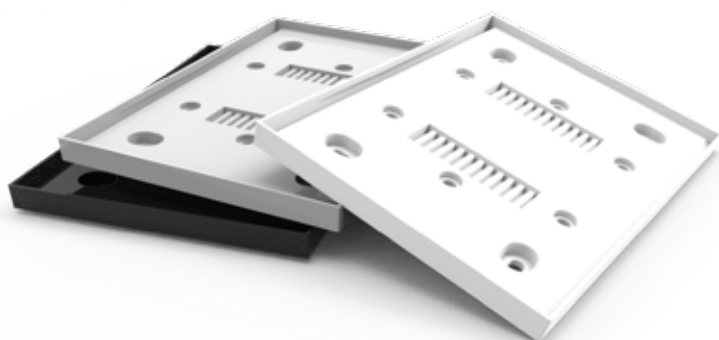

The frames, which are available in sizes DIN A6, DIN A5, DIN A4, DIN A3, 150x150mm and 150x300mm, are injection molded in abs plastic and are available in different colors.

Standard colors are aluminium grey and black.

Les cadres, disponibles en DIN A6, DIN A5, DIN A4, DIN A3, 150x150mm et 150x300mm, sont moulés en plastique ABS (processus d'injection) et disponibles en différentes couleurs.

Les couleurs standard sont gris aluminium et noir.

I-SIGN ECO FLEX

WALL MOUNTED / FIXATION MURALE

I-Sign Eco Flex Wall Mounted. Included: I-Sign Eco Frame, Acrylic cover.

I-Sign Eco Fixation Murale. Inclus: Cadre I-Sign Eco, Face acrylique.

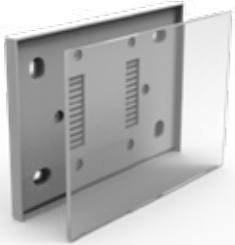

product code	insert (hwx) in mm
IE-150150-W-X	150 x 150
IE-150300-W-X	150 x 300
IE-105148-W-X	105 x 148,5 (DIN A6)
IE-210148-W-X	210 x 148,5 (DIN A5)
IE-210297-W-X	210 x 297 (DIN A4)
IE-420297-W-X	420 x 297 (DIN A3)

X = colour code:

W: White, B: Black, G: Grey
(Other colours available on request.)

X = Code de couleur:

W: Blanc, B: Noir, G: Gris
(Autres couleurs disponibles sur demande.)

PROJECTED / FIXATION EN DRAPEAU

I-Sign Eco Flex Projected. Fully assembled including: 2x I-Sign Eco Frames, Connection Pins, Interior Cover, Flag system, Acrylic covers.

I-Sign Eco Fixation en Drapeau. Entièrement assemblé inclus: 2x Cadre I-Sign Eco, Connexions, Couverture l'intérieur, Système en drapeau, Faces acryliques.



product code	insert (hwx) in mm
IE-150150-P-X	150 x 150
IE-150300-P-X	150 x 300
IE-210297-P-X	210 x 297 (DIN A4 landscape)
IE-297210-P-X	297 x 210 (DIN A4 portrait)

X = colour code:

W: White, B: Black, G: Grey
(Other colours available on request.)

X = Code de couleur:

W: Blanc, B: Noir, G: Gris
(Autres couleurs disponibles sur demande.)

SUSPENDED / SYSTÈME DE SUSPENSION

I-Sign Eco Flex Suspended. Included: 2x I-Sign Eco Frames, Connection Pins, Interior Cover, Suspension cables, Acrylic covers.

I-Sign Eco Flex Systeme de suspension. Entièrement assemblé inclus: 2x Cadres I-Sign Eco, Connexions, Couverture l'intérieur, Fils de suspension, Faces acryliques.

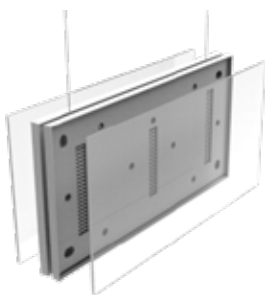

product code	insert (hwx) in mm
IE-150150-S-X	150 x 150
IE-150300-S-X	150 x 300
IE-210297-S-X	210 x 297 (DIN A4 landscape)
IE-297210-S-X	297 x 210 (DIN A4 portrait)

X = colour code:

W: White, B: Black, G: Grey
(Other colours available on request.)

X = Code de couleur:

W: Blanc, B: Noir, G: Gris
(Autres couleurs disponibles sur demande.)

See also page 52 in our architectural brochure for more suspension systems.

Voir également page 52 dans notre brochure architectural pour plus d'infos sur nos systèmes de suspension.

ACCESSORIES / ACCESSOIRES



product code	description
IE-CONNECTOR	Connector to combine two I-Sign Eco frames. Connexion pour connecter deux cadre I-Sign Eco.



APC-3000-S	Suspension Clip. Clip de suspension.
------------	---



APC-CABLE-1.5	1.5mm thick galvanized cable (7x7). 1,5m length with 4,5mm ball nipple.
---------------	--

1.5mm fil galvanisé (7x7) 1,5m de longueur avec un téton sphérique de 4,5mm de diamètre.



I-FLAG3-100	I-Flag 3 profile with mount 100mm I-Flag 3 profilé avec support 100mm
-------------	--

I-FLAG3-150	I-Flag 3 profile with mount 150mm I-Flag 3 profilé avec support 150mm
-------------	--

I-SIGN ECO FIX

WALL MOUNTED / FIXATION MURALE

I-Sign Eco Flex Wall Mounted. Included: I-Sign Eco Frame.

I-Sign Eco Fixation Mural. Inclus: I-Sign Eco Cadre.



product code	insert (hwx) in mm
IFE-150150-W-X	150 x 150
IFE-150300-W-X	150 x 300
IFE-105148-W-X	105 x 148,5 (DIN A6)
IFE-210148-W-X	210 x 148,5 (DIN A5)
IFE-210297-W-X	210 x 297 (DIN A4)
IFE-420297-W-X	420 x 297 (DIN A3)

X = colour code:

W: White, B: Black, G: Grey
(Other colours available on request.)

X = Code de couleur:

W: Blanc, B: Noir, G: Gris
(Autres couleurs disponibles sur demande.)

PROJECTED / FIXATION EN DRAPEAU

I-Sign Eco Flex Projected. Fully assembled including: 2x I-Sign Eco Frames, Connection Pins, Interior Cover, Flag system.

I-Sign Eco Fixation en Drapeau. Entièrement assemblé inclus: 2x I-Sign Eco Cadre, , Couverture l'intérieur, Système en drapeau.

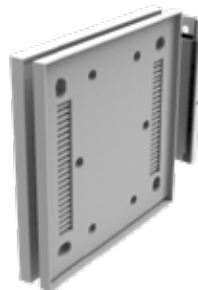

product code	insert (hwx) in mm
IFE-150150-P-X	150 x 150
IFE-150300-P-X	150 x 300
IFE-210297-P-X	210 x 297 (DIN A4 landscape)
IFE-297210-P-X	297 x 210 (DIN A4 portrait)

X = colour code:

W: White, B: Black, G: Grey
(Other colours available on request.)

X = Code de couleur:

W: Blanc, B: Noir, G: Gris
(Autres couleurs disponibles sur demande.)

ACCESSORIES / ACCESSOIRES

product code description

	IE-COV150150 Cover to hide I-Sign Eco frame interior. For 150x150mm projected. Couverture pour cacher l'intérieur de l'assemblage Pour 150x150mm fixation en drapeau
	IE-COV150300 Cover to hide I-Sign Eco frame interior. For 150x300mm suspended. Couverture pour cacher l'intérieur de l'assemblage Pour 150x300mm système de suspension
	IE-COV300150 Cover to hide I-Sign Eco frame interior. For 150x300mm projected. Couverture pour cacher l'intérieur de l'assemblage Pour 300x150mm fixation en drapeau
	IE-COV210297 Cover to hide I-Sign Eco frame interior. For 210x297mm suspended. Couverture pour cacher l'intérieur de l'assemblage Pour 150x150mm système de suspension
	IE-COV297210 Cover to hide I-Sign Eco frame interior. For 210x297mm projected. Couverture pour cacher l'intérieur de l'assemblage Pour 150x150mm fixation en drapeau

SUSPENDED / SYSTÈME DE SUSPENSION

I-Sign Eco Flex Suspended. Included: 2x I-Sign Eco Frames, Connection Pins, Interior Cover, Suspension cables.

I-Sign Eco Flex Systeme de suspension. Entièrement assemblé inclus: 2x Cadres I-Sign Eco, Couverture l'intérieur, Connexions, Fils de suspension.

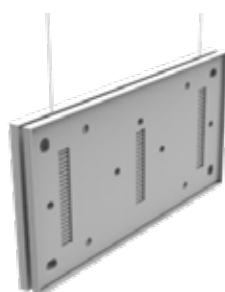

product code	insert (hwx) in mm
IFE-150150-S-X	150 x 150
IFE-150300-S-X	150 x 300
IFE-210297-S-X	210 x 297 (DIN A4 landscape)
IFE-297210-S-X	297 x 210 (DIN A4 portrait)

X = colour code:

W: White, B: Black, G: Grey
(Other colours available on request.)

X = Code de couleur:

W: Blanc, B: Noir, G: Gris
(Autres couleurs disponibles sur demande.)

See also page 52 in our architectural brochure for more suspension systems.

Voir également page 52 dans notre brochure architectural pour plus d'infos sur nos systèmes de suspension.